

Introduction to Physical Metallurgy and Engineering Materials

Lecture Notes

By

Prof. Pravata Ranjan Kaunr

Lecturer
Department of Mechanical Engineering
Hi-Tech institute of Technology, Khurda (HIT)
Bhubaneswar, Odisha

PME3I001- INTRODUCTION TO PHYSICAL METALLURGY AND ENGINEERING MATERIALS

Syllabus

MODULE-I (08 Lectures)

Classification of Engineering Materials, Engineering properties of materials. Characteristic property of metals, bonding in solids, primary bonds like ionic, covalent and metallic bond, crystal systems, common crystal structure of metals, representations of planes and directions in crystals, atomic packing in crystals, calculation of packing density, voids in common crystal structures and imperfections crystals.

MODULE-II (08 Lectures)

Concept of plastic deformation of metals, critical resolve shear stress, dislocation theory, deformation by slip and twin, plastic deformation in polycrystalline metals, yield point phenomenon and related effects, concept of cold working preferred orientation. Annealing; recovery; recrystallization and grain growth; hot working.

Concept of alloy formation, types of alloys, solid solutions, factors governing solids solubility viz. size factor, valency factor, crystal structure factor and chemical affinity factor; order-disorder transformation.

MODULE-III (10 Lectures)

Binary phase diagrams (a) Isomorphism system, (b) Eutectic system, (c) Peritectic system, (d)Eutectoid system and (e) Peritectoid system. Allotropic transformation. Lever rule and its application, Interpretation of solidification behaviors and microstructure of different alloys belonging to those systems, Effect of non-equilibrium cooling, coring and homogenization.

Iron-cementite and iron-graphite phase diagrams, microstructure and properties of different alloys (alloy steels; stainless steel, tool steel, HSS, high strength low alloy steel) types of cast iron, their microstructures and typical uses. Specification of steel.

T.T.T. diagram: concept of heat treatment of steels i.e. annealing, normalizing, hardening and tempering; microstructural effects brought about by these processes and their influences on mechanical properties; factor affecting hardenability.

MODULE-IV (10 Lectures)

Optical properties of Materials: Scattering, Refraction, Theory of Refraction and absorption, Atomic Theory of optical properties. Lasers, Optical fibres- Principle, structure, application of optical fibres.

Plastic:-Thermosetting and thermoplastics.

Ceramics: Types, structure, Mechanical properties, application

Composite Materials: Agglomerated Materials: Cermets .Reinforced Materials: Reinforced Concrete. Fibre reinforced plastics, Properties of composites, Metal matrix composites, manufacturing procedure for fiber reinforced composite.

Text Books:

1. Introduction to Physical Metallurgy by Avner, Tata McGraw Hill
2. Materials Science and Engineering by W.D.Callister, Wiley and Sons Inc.
3. Physical Metallurgy: Principles and Practice by Ragahvan, PHI

Reference Books

1. Engineering Physical Metallurgy and Heat Treatment by Y.Lakhtin, Mir Publisher, Moscow.
2. Elements of Material Science and Engineering, L.H.Van Vlack, Addison Wesley
3. Materials Science and Engineering by V.Raghavan, Prentice Hall of India Pvt.Ltd.
4. Elements of Materials Science & Engineering by Van Vlack, Pearson
5. Mechanical Metallurgy by Dieter, Tata MacGraw Hill
6. Composite Material science and Engineering by K. K. Chawla, Springer
7. Material Science and Metallurgy, by U. C. Jindal, Pearson

Contents

<i>Topic</i>	<i>Page No.</i>
Syllabus.....	02
Module-1.....	05
Module-2	33
Module-3.....	52
Module-4	96

Module-1

Materials Science

As engineering materials constitute foundation of technology, it's not only necessary but a must to understand how materials behave like they do and why they differ in properties. This is only possible with the atomistic understanding allowed by quantum mechanics that first explained atoms and then solids starting in the 1930s. The combination of physics, chemistry, and the focus on the relationship between the properties of a material and its microstructure is the domain of Materials Science. The development of this science allowed designing materials and provided a knowledge base for the engineering applications (Materials Engineering).

Important components of the subject Materials Science are structure, properties, processing, and performance. A schematic interrelation between these four components is shown in figure.

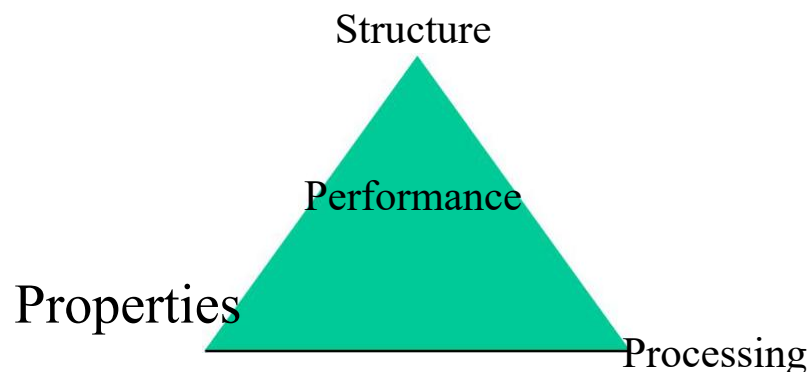

Figure: *Interrelation between four components of Materials Science.*

Why Study Materials Science and Engineering?

All engineers need to know about materials. Even the most "immaterial", like software or system engineering depend on the development of new materials, which in turn alter the

economics, like software-hardware trade-offs. Increasing applications of system engineering are in materials manufacturing (industrial engineering) and complex environmental systems.

Innovation in engineering often means the clever use of a new material for a specific application. For example: plastic containers in place of age-old metallic containers. It is well learnt lesson that engineering disasters are frequently caused by the misuse of materials. So it is vital that the professional engineer should know how to select materials which best fit the demands of the design - economic and aesthetic demands, as well as demands of strength and durability. Beforehand the designer must understand the properties of materials, and their limitations. Thus it is very important that every engineer must study and understand the concepts of Materials Science and Engineering. This enables the engineer

- To select a material for a given use based on considerations of cost and performance.
- To understand the limits of materials and the change of their properties with use.
- To be able to create a new material that will have some desirable properties.
- To be able to use the material for different application.

Classification of Materials

Like many other things, materials are classified in groups, so that our brain can handle the complexity. One can classify them based on many criteria, for example crystal structure (arrangement of atoms and bonds between them), or properties, or use. Metals, Ceramics, Polymers, Composites, Semiconductors, and Biomaterials constitute the main classes of present engineering materials.

1. Metals:

These materials are characterized by high thermal and electrical conductivity; strong yet deformable under applied mechanical loads; opaque to light (shiny if polished). These characteristics are due to valence electrons that are detached from atoms, and spread in an *electron sea* that *glues* the ions together, i.e. atoms are bound together by metallic bonds and weaker van der Waals forces. Pure metals are not good enough for many applications, especially structural applications. Thus metals are used in alloy form i.e. a metal mixed with another metal to improve the desired qualities. E.g.: aluminum, steel, brass, gold.

2. Ceramics:

These are inorganic compounds, and usually made either of oxides, carbides, nitrides, or silicates of metals. Ceramics are typically partly crystalline and partly amorphous. Atoms (ions often) in ceramic materials behave mostly like either positive or negative ions, and are bound by very strong Coulomb forces between them. These materials are characterized by very high strength under compression, low ductility; usually insulators to heat and electricity. Examples: glass, porcelain, many minerals.

3. Polymers:

Polymers in the form of thermo-plastics (nylon, polyethylene, polyvinyl chloride, rubber, etc.) consist of molecules that have covalent bonding within each molecule and van der Waals forces between them. Polymers in the form of thermo-sets (e.g., epoxy, phenolics, etc.) consist of a network of covalent bonds. They are based on H, C and other non-metallic elements. Polymers are amorphous, except for a minority of thermoplastics. Due to the kind of bonding, polymers are typically electrical and thermal insulators. However, conducting polymers can be obtained by doping, and conducting polymer-matrix composites can be obtained by the use of conducting fillers. They decompose at moderate temperatures (100 – 400 C), and are lightweight. Other properties vary greatly.

4. Composite materials:

Composite materials are multiphase materials obtained by artificial combination of different materials to attain properties that the individual components cannot attain. An example is a lightweight brake disc obtained by embedding SiC particles in Al-alloy matrix. Another example is reinforced cement concrete, a structural composite obtained by combining cement (the matrix, i.e., the binder, obtained by a reaction known as hydration, between cement and water), sand (fine aggregate), gravel (coarse aggregate), and, thick steel fibers. However, there are some natural composites available in nature, for example – wood. In general, composites are classified according to their matrix materials. The main classes of composites are metal-matrix, polymer-matrix, and ceramic-matrix.

5. Semiconductors:

Semiconductors are covalent in nature. Their atomic structure is characterized by the highest occupied energy band (the valence band, where the valence electrons reside energetically) full such that the energy gap between the top of the valence band and the bottom of the empty energy band (the conduction band) is small enough for some fraction of the valence electrons to be excited from the valence band to the conduction band by thermal, optical, or other forms of energy. Their electrical properties depend extremely strongly on minute proportions of contaminants. They are usually doped in order to enhance electrical conductivity. They are used in the form of single crystals without dislocations because grain boundaries and dislocations would degrade electrical behavior. They are opaque to visible light but transparent to the infrared. Examples: silicon (Si), germanium (Ge), and gallium arsenide (GaAs, a compound semiconductor).

6. Biomaterials:

These are any type material that can be used for replacement of damaged or diseased human body parts. Primary requirement of these materials is that they must be biocompatible with body tissues, and must not produce toxic substances. Other important material factors are: ability to support forces; low friction, wear, density, and cost;

reproducibility. Typical applications involve heart valves, hip joints, dental implants, intraocular lenses. Examples: Stainless steel, Co-28Cr-6Mo, Ti-6Al-4V, ultra high molecular weight poly-ethelene, high purity dense Al-oxide, etc.

Advanced Materials, Future Materials, and Modern Materials needs

1. Advanced Materials

These are materials used in *High-Tech* devices those operate based on relatively intricate and sophisticated principles (e.g. computers, air/space-crafts, electronic gadgets, etc.). These materials are either traditional materials with enhanced properties or newly developed materials with high-performance capabilities. Hence these are relatively expensive. Typical applications: integrated circuits, lasers, LCDs, fiber optics, thermal protection for space shuttle, etc. Examples: Metallic foams, inter-metallic compounds, multi-component alloys, magnetic alloys, special ceramics and high temperature materials, etc.

2. Future Materials

Group of new and state-of-the-art materials now being developed, and expected to have significant influence on present-day technologies, especially in the fields of medicine, manufacturing and defense. Smart/Intelligent material system consists some type of sensor (*detects an input*) and an actuator (*performs responsive and adaptive function*). Actuators may be called upon to change shape, position, natural frequency, mechanical characteristics in response to changes in temperature, electric/magnetic fields, moisture, pH, etc.

Four types of materials used as actuators: Shape memory alloys, Piezo-electric ceramics, Magnetostrictive materials, Electro-/Magneto-rheological fluids. Materials / Devices used as sensors: Optical fibers, Piezo-electric materials, Micro-electro-mechanical systems (MEMS), etc.

Typical applications: By incorporating sensors, actuators and chip processors into system, researchers are able to stimulate biological human-like behavior; Fibers for bridges, buildings, and wood utility poles; They also help in fast moving and accurate robot parts, high speed helicopter rotor blades; Actuators that control chatter in precision machine tools; Small microelectronic circuits in machines ranging from computers to photolithography prints; Health monitoring detecting the success or failure of a product.

3. Modern Materials needs

Though there has been tremendous progress over the decades in the field of materials science and engineering, innovation of new technologies, and need for better performances of existing technologies demands much more from the materials field. More over it is evident that new materials/technologies are needed to be environmental friendly. Some typical needs, thus, of modern materials needs are listed in the following:

- Engine efficiency increases at high temperatures: requires high temperature structural materials
- Use of nuclear energy requires solving problem with residues, or advances in nuclear waste processing.
- Hypersonic flight requires materials that are light, strong and resist high temperatures.
- Optical communications require optical fibers that absorb light negligibly.
- Civil construction – materials for unbreakable windows.
- Structures: materials that are strong like metals and resist corrosion like plastics.

Atomic Structure and Atomic Bonding in Solids

Atomic Structure

Atoms are composed of electrons, protons, and neutrons. Electrons and protons are negative and positive charged particles respectively. The magnitude of each charged particle in an atom is 1.6×10^{-19} Coulombs.

The mass of the electron is negligible with respect to those of the proton and the neutron, which form the *nucleus* of the atom. The unit of mass is an atomic mass unit (*amu*) = 1.66×10^{-27} kg, and equals 1/12 the mass of a carbon atom. The Carbon nucleus has $Z=6$, and $A=6$, where Z is the number of protons, and A the number of neutrons. Neutrons and protons have very similar masses, roughly equal to 1 *amu* each. A neutral atom has the same number of electrons and protons, Z .

A *mol* is the amount of matter that has a mass in grams equal to the atomic mass in *amu* of the atoms. Thus, a mole of carbon has a mass of 12 *grams*. The number of atoms in a mole is called the Avogadro number, $N_{AV} = 6.023 \times 10^{23}$. Note that $N_{AV} = 1 \text{ gram}/1 \text{ amu}$.

For a molecular solid like ice, one uses the molecular mass, $M(\text{H}_2\text{O}) = 18$. With a density of 1 g/cm^3 , one obtains $n = 3.3 \times 10^{22}$ H_2O molecules/ cm^3 . Note that since the water molecule contains 3 atoms, this is equivalent to 9.9×10^{22} atoms/ cm^3 .

Most solids have atomic densities around 6×10^{22} atoms/ cm^3 . The cube root of that number gives the number of atoms per centimeter, about 39 million. The mean distance between atoms is the inverse of that, or 0.25 nm. This is an important number that gives the scale of atomic structures in solids.

Atomic bonding in solids

In order to understand the why materials behave like they do and why they differ in properties, it is necessary that one should look at atomic level. The study primarily concentrates on two issues: what made the atoms to cluster together, and how atoms are arranged. As mentioned in earlier chapter, atoms are bound to each other by number of bonds. These inter-atomic bonds are primarily of two kinds: Primary bonds and Secondary bonds. Ionic, Covalent and Metallic bonds are relatively very strong, and grouped as primary bonds, whereas van der Waals and hydrogen bonds are relatively weak, and termed as secondary bonds. Metals and Ceramics are entirely held together by primary bonds - the ionic and covalent bonds in ceramics, and the metallic and covalent bonds in metals. Although much weaker than primary bonds, secondary bonds are still very important. They provide the links between polymer molecules in polyethylene (and other polymers) which make them solids. Without them, water would boil at -80°C , and life as we know it on earth would not exist.

Ionic Bonding:

This bond exists between two atoms when one of the atoms is negative (has an extra electron) and another is positive (has lost an electron). Then there is a strong, direct Coulomb attraction. Basically ionic bonds are non-directional in nature. An example is NaCl. In the molecule, there are more electrons around Cl, forming Cl^{-} and fewer electrons around Na, forming Na^{+} . Ionic bonds are the strongest bonds. In real solids, ionic bonding is usually exists along with covalent bonding.

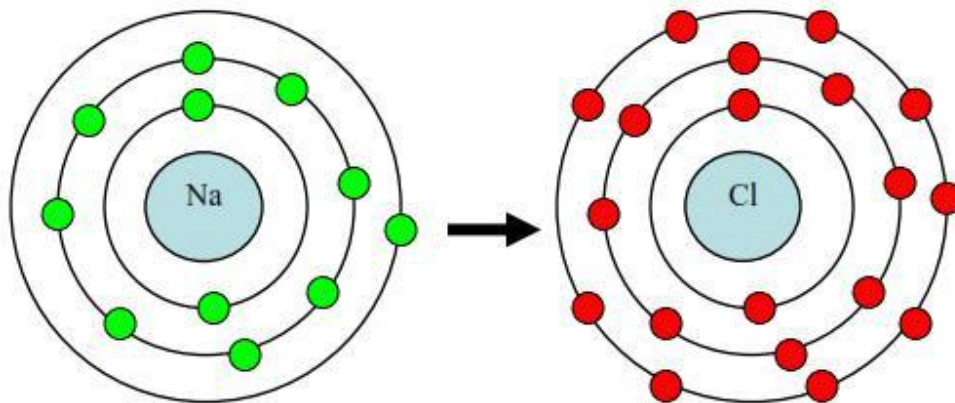

Fig.1 Schematic representation of ionic bonding. Here, Na is giving an electron to Cl to have stable structure

Covalent Bonding:

In covalent bonding, electrons are shared between the atoms, to saturate the valency. The simplest example is the H_2 molecule, where the electrons spend more time in between the nuclei of two atoms than outside, thus producing bonding. Covalent bonds are stereospecific i.e. each bond is between a specific pair of atoms, which share a pair of electrons (of opposite magnetic spins). Typically, covalent bonds are very strong, and directional in nature. The hardness of diamond is a result of the fact that each carbon atom is covalently bonded with four neighboring atoms, and each neighbor is bonded with an equal number of atoms to form a rigid three-dimensional structure.

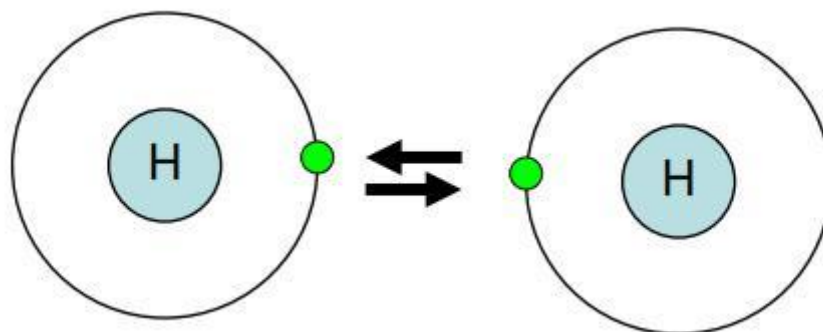

Figure 2. Schematic representation of covalent bond in Hydrogen molecule (sharing of electrons)

Metallic Bonding:

Metals are characterized by high thermal and electrical conductivities. Thus, neither covalent nor ionic bondings are realized because both types of bonding localize the valence electrons and preclude conduction. However, strong bonding does occur in metals. The valence electrons of metals also are delocalized. Thus metallic bonding can be viewed as metal containing a periodic structure of positive ions surrounded by a sea of delocalized electrons. The attraction between the two provides the bond, which is non-directional.

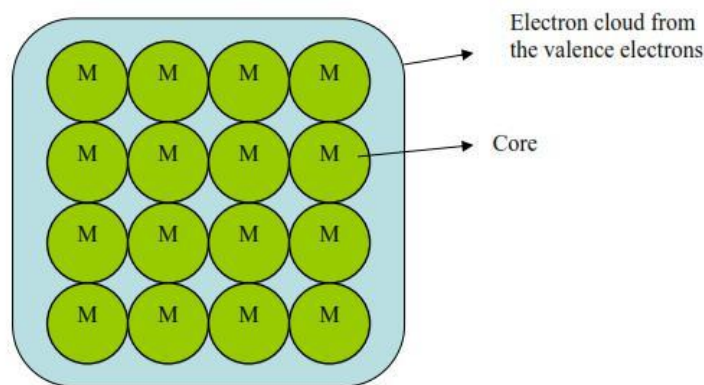

Figure 3. Metallic bonding

Crystal Structures, Crystalline and Non-Crystalline materials

1. Crystal structures

All metals, a major fraction of ceramics, and certain polymers acquire crystalline form when solidify, i.e. in solid state atoms self-organize to form *crystals*. Crystals possess a long-range order of atomic arrangement through repeated periodicity at regular intervals in three dimensions of space. When the solid is not crystalline, it is called amorphous. Examples of crystalline solids are metals, diamond and other precious stones, ice, graphite. Examples of amorphous solids are glass, amorphous carbon (a-C), amorphous Si, most plastics.

There is very large number of different crystal structures all having long-range atomic order; these vary from relatively simple structures for metals to exceedingly complex

structures for ceramics and some polymers. To discuss crystalline structures it is useful to consider atoms as being hard spheres, with well-defined radii. In this scheme, the shortest distance between two like atoms is one diameter. In this context, use of terms *lattice* and *unit cell* will be handy. *Lattice* is used to represent a three-dimensional periodic array of points coinciding with atom positions. *Unit cell* is smallest repeatable entity that can be used to completely represent a crystal structure. Thus it can be considered that a unit cell is the building block of the crystal structure and defines the crystal structure by virtue of its geometry and the atom positions within.

Important properties of the unit cells are

- The type of atoms and their radii R .
- Cell dimensions (Lattice spacing a , b and c) in terms of R and
- Angle between the axis α , β , γ
- a^* , b^* , c^* - lattice distances in reciprocal lattice, α^* , β^* , γ^* - angle in reciprocal lattice
- n , number of atoms per unit cell. For an atom that is shared with m adjacent unit cells, we only count a fraction of the atom, $1/m$.
- CN , the coordination number, which is the number of closest neighbors to which an atom is bonded.
- APF , the atomic packing factor, which is the fraction of the volume of the cell actually occupied by the hard spheres. $APF = \text{Sum of atomic volumes}/\text{Volume of cell}$.

Some very common crystal structures and relevant properties are listed in table.

Table: Common crystal structures and their properties.

Unit Cell	n	CN	a/R	APF
Simple Cubic	1	6	$4/\sqrt{4}$	0.52
Body-Centered Cubic	2	8	$4/\sqrt{3}$	0.68
Face-Centered Cubic	4	12	$4/\sqrt{2}$	0.74
Hexagonal Close Packed	6	12		0.74

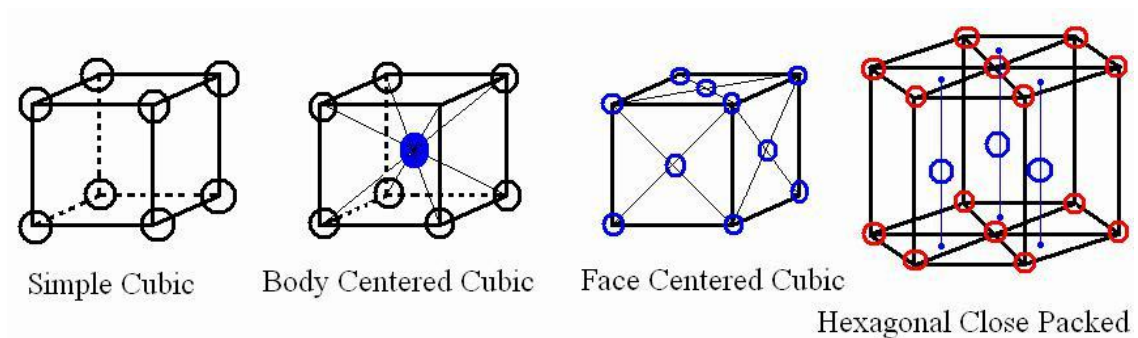

Figure: Common metallic crystal structures.

Crystalline and Non-crystalline materials

Single Crystals:

Crystals can be *single crystals* where the whole solid is one crystal. Then it has a regular geometric structure with flat faces.

Polycrystalline Materials:

A solid can be composed of many crystalline grains, not aligned with each other. It is called *polycrystalline*. The grains can be more or less aligned with respect to each other. Where they meet is called a *grain boundary*.

Non-Crystalline Solids:

In amorphous solids, there is no long-range order. But amorphous does not mean random, since the distance between atoms cannot be smaller than the size of the hard spheres. Also, in many cases there is some form of short-range order. For instance, the tetragonal order of crystalline SiO₂ (quartz) is still apparent in amorphous SiO₂ (silica glass).

Miller Indices, Anisotropy, and Elastic behavior of composites

Miller indices:

It is understood that properties of materials depend on their crystal structure, and many of these properties are directional in nature. For example: elastic modulus of BCC iron is greater parallel to the body diagonal than it is to the cube edge. Thus it is necessary to characterize the crystal to identify specific directions and planes. Specific methods are employed to define crystal directions and crystal planes.

Methodology to define crystallographic directions in cubic crystal:

- a vector of convenient length is placed parallel to the required direction.
- the length of the vector projection on each of three axes are measured in unit cell dimensions.
- these three numbers are made to smallest integer values, known as indices, by multiplying or dividing by a common factor.
- the three indices are enclosed in square brackets, $[uvw]$. A family of directions is represented by $\langle uvw \rangle$.

Methodology to define crystallographic planes in cubic crystal:

- determine the intercepts of the plane along the crystallographic axes, *in terms of unit cell dimensions*. If plane is passing through origin, there is a need to construct a plane parallel to original plane.
- take the reciprocals of these intercept numbers.

- clear fractions.
- reduce to set of smallest integers.
- The three indices are enclosed in parenthesis, (hkl) . A family of planes is represented by $\{hkl\}$.

For example, if the x-, y-, and z- intercepts of a plane are 2, 1, and 3. The Miller indices are calculated as:

- take reciprocals: $1/2, 1/1, 1/3$.
- clear fractions (multiply by 6): 3, 6, 2.
- reduce to lowest terms (already there). \Rightarrow Miller indices of the plane are (362).

Figure depicts Miller indices for number of directions and planes in a cubic crystal.

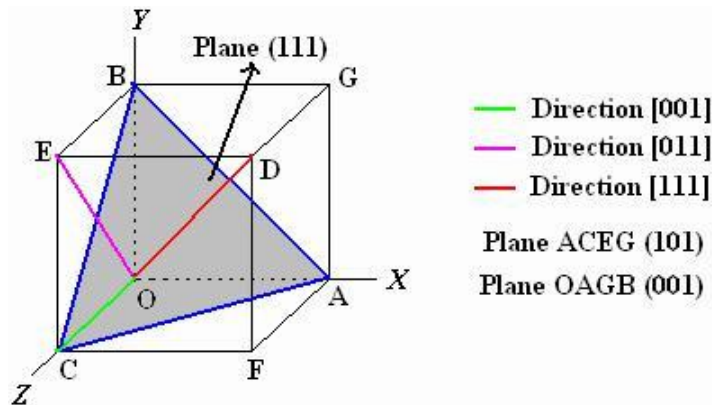

Figure : Miller indices in a cubic crystal.

Some useful conventions of Miller notation:

- If a plane is parallel to an axis, its intercept is at infinity and its Miller index will be zero.
- If a plane has negative intercept, the negative number is denoted by a bar above the number. *Never alter negative numbers.* For example, do not divide -1, -1, -1 by -1 to get 1,1,1. This implies symmetry that the crystal may not have!
- The crystal directions of a family are not necessarily parallel to each other. Similarly, not all planes of a family are parallel to each other.
- By changing signs of all indices of a direction, we obtain opposite direction.

Similarly, by changing all signs of a plane, a plane at same distance in other side of the origin can be obtained.

- Multiplying or dividing a Miller index by constant has no effect on the orientation of the plane.
- The smaller the Miller index, more nearly parallel the plane to that axis, and vice versa.
- When the integers used in the Miller indices contain more than one digit, the indices must be separated by commas. E.g.: (3,10,13)
- By changing the signs of all the indices of (a) a direction, we obtain opposite direction, and (b) a plane, we obtain a plane located at the same distance on the other side of the origin.

Why Miller indices are calculated in that way?

- Using reciprocals spares us the complication of infinite intercepts.
- Formulas involving Miller indices are very similar to related formulas from analytical geometry.
- Specifying dimensions in unit cell terms means that the same label can be applied to any plane with a similar stacking pattern, regardless of the crystal class of the crystal. Plane (111) always steps the same way regardless of crystal system.

Miller-Bravis indices

Though Miller indices can describe all possible planes through any crystal, Miller-Bravis indices are used in hexagonal crystal systems. This is because they reveal hexagonal symmetry more clearly. Although partially redundant, they are used exclusively for hexagonal systems.

Direction indices are obtained as above where first three indices are representative of projections of the direction over three co-planar axes in the plane called basal plane while the last index denotes the projection over the axis perpendicular to the basal plane. Miller-Bravis indices for a plane are denoted as $[uvtw]$, where $t = -(u+v)$

In the same procedure, planes in a hexagonal crystal are denoted by $(hkil)$, where $i = -(h+k)$.

Anisotropy

It's been agreed that many of the materials properties depend on the crystal structure. However, crystals are not symmetric in all directions, or not the crystal planes same with respect to atomic density/packing. Different directions in the crystal have different packing. For instance, atoms along the edge of FCC crystals are more separated than along its face diagonal. This causes properties to be different in different directions. This directionality of properties is termed as *Anisotropy*.

Substances in which measured properties are independent of direction in which they are measured are called *isotropic*. Though, in polycrystalline materials, the crystallographic orientations of individual grains are random, specimen may behave isotropically.

Imperfections in Solids

Theoretical yield strength, Point defects, Line defects and Dislocations *Theoretical strength*

Atoms are orderly arranged without any disruptions in ideal solids. Under mechanical loads, all solids tend to reshape themselves. This occurs usually by process called slip, the translation of one plane of atoms over another under implied shear stresses.

Consider two planes of atoms subjected a shear stress under applied load. Let's assume, as shown in *figure*, distance between atoms in slip direction is b , and spacing between the two planes is a .

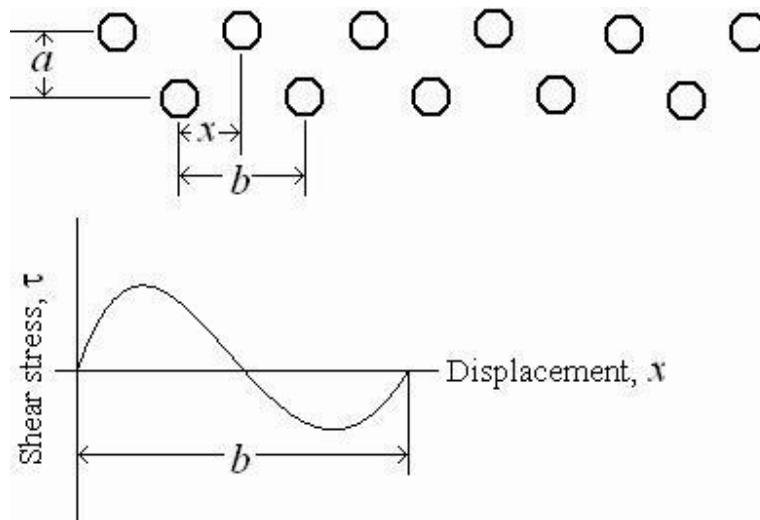

Shear displacement of atom planes and variation of shear stress.

a. Point defects

Defects exist in all solid materials. For ease of their characterization, defects are classified on the basis of their geometry, which is realistic as defects are disrupted regions in a volume of a solid. Defects are:

- a. Point defects (zero-dimensional)
- b. Line defects (single dimensional)
- c. Surface defects (two dimensional)
- d. Volume defects (three dimensional)

Point defects, as the name implies, are imperfect point-like regions in the crystal. Typical size of a point defect is about 1-2 atomic diameters. Different point defects are explained in the following paragraphs. *Figure-3.2* depicts various point defects.

A **vacancy** is a vacant lattice position from where the atom is missing. It is usually created when the solid is formed by cooling the liquid. There are other ways of making a vacancy, but they also occur naturally as a result of thermal excitation, and these are thermodynamically stable at temperatures greater than zero. At equilibrium, the fraction

of lattice sites that are vacant at a given temperature (T) are:

$$\frac{n}{N} = e^{-\frac{Q}{kT}}$$

where n is the number of vacant sites in N lattice positions, k is gas or Boltzmann's constant, T is absolute temperature in kelvins, and Q is the energy required to move an atom from the interior of a crystal to its surface. It is clear from the equation that there is an exponential increase in number of vacancies with temperature. When the density of vacancies becomes relatively large, there is a possibility for them to cluster together and form voids.

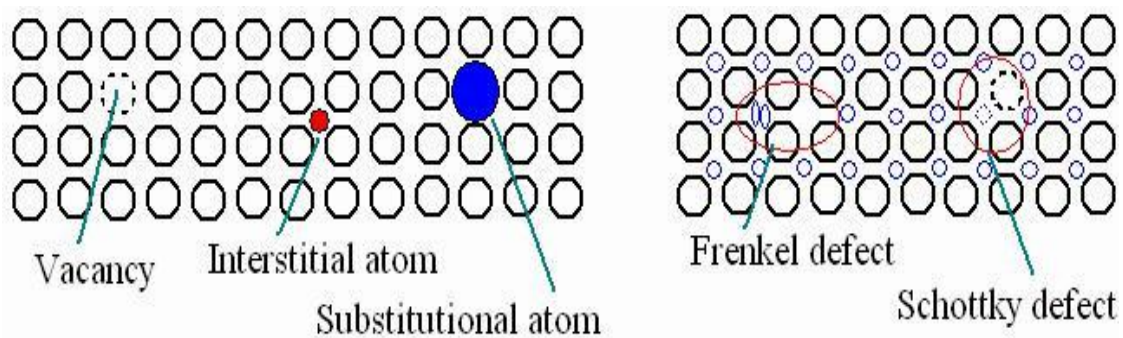

Figure-: Schematic depiction of various point defects

An *interstitial atom* or *interstitialcy* is an atom that occupies a place outside the normal lattice position. It may be the same type of atom as the rest surrounding it (self interstitial) *or* a foreign impurity atom. Interstitialcy is most probable if the atomic packing factor is low.

Another way an impurity atom can be fitted into a crystal lattice is by substitution. A *substitutional atom* is a foreign atom occupying original lattice position by displacing the parent atom.

In the case of vacancies and foreign atoms (both interstitial and substitutional), there is a change in the coordination of atoms around the defect. This means that the forces are not

balanced in the same way as for other atoms in the solid, which results in lattice distortion around the defect.

In ionic crystals, existence of point defects is subjected to the condition of charge neutrality.

There are two possibilities for point defects in ionic solids.

- when an ion displaced from a regular position to an interstitial position creating a vacancy, the pair of vacancy-interstitial is called *Frenkel defect*. Cations are usually smaller and thus displaced easily than anions. Closed packed structures have fewer interstitials and displaced ions than vacancies because additional energy is required to force the atoms into the interstitial positions.

- a pair of one cation and one anion can be missing from an ionic crystal, without violating the condition of charge neutrality when the valency of ions is equal. The pair of vacant sites, thus formed, is called *Schottky defect*. This type of point defect is dominant in alkali halides. These *ion-pair vacancies*, like single vacancies, facilitate atomic diffusion.

b. Line defects or Dislocations:

Line imperfections (one-dimensional defects) are also called Dislocations. They are abrupt changes in the regular ordering of atoms along a line (dislocation line) in the solid. They occur in high densities and strongly influence the mechanical properties of material. They are characterized by the Burgers vector (***b***), whose direction and magnitude can be determined by constructing a loop around the disrupted region and noticing the extra inter-atomic spacing needed to close the loop. The Burgers vector in metals points in a close packed lattice direction. It is unique to a dislocation.

Dislocations occur when an extra incomplete plane is inserted. The dislocation line is at the end of the plane. Dislocations can be best understood by referring to two limiting cases - Edge dislocation *and* Screw dislocation.

Edge dislocation or *Taylor-Orowan dislocation* is characterized by a Burger's vector that is perpendicular to the dislocation line. It may be described as an edge of an extra plane of atoms within a crystal structure. Thus regions of compression and tension are associated with an edge dislocation. Because of extra incomplete plane of atoms, the atoms above the dislocation line are squeezed together and are in state of compression whereas atoms below are pulled apart and experience tensile stresses. Edge dislocation is considered *positive* when compressive stresses present above the dislocation line, and is represented by \ominus . If the stress state is opposite i.e. compressive stresses exist below the dislocation line, it is considered as negative edge dislocation, and represented by \oplus . A schematic view of edge dislocations are shown in *figure*.

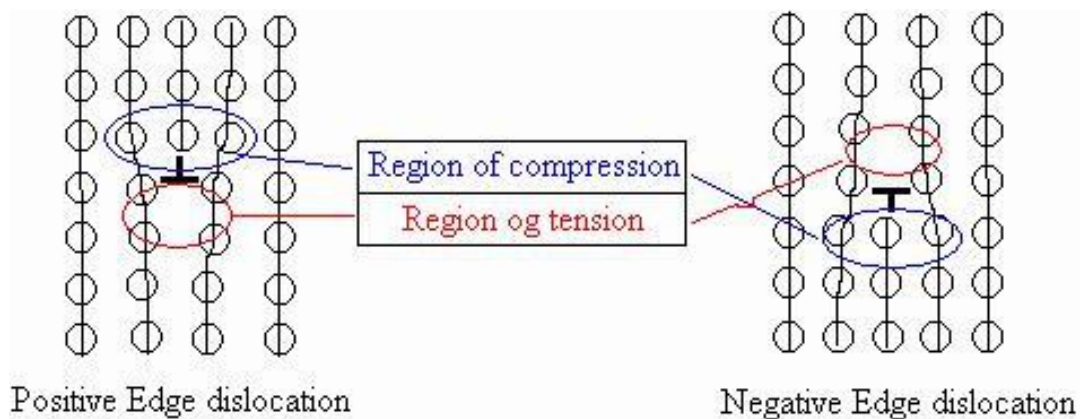

Figure: Edge dislocations.

A pure edge dislocation can glide or slip in a direction perpendicular to its length i.e. along its Burger's vector in the slip plane (made of \mathbf{b} and \mathbf{t} vectors), on which dislocation moves by slip while conserving number of atoms in the incomplete plane. It may move vertically by a process known as climb, if diffusion of atoms or vacancies can take place at appropriate rate. Atoms are added to the incomplete plane for negative climb i.e. the incomplete plane increases in extent downwards, and vice versa. Thus climb motion is considered as non-conservative, the movement by climb is controlled by diffusion process.

Screw dislocation or *Burgers dislocation* has its dislocation line parallel to the Burger's vector. A screw dislocation is like a spiral ramp with an imperfection line down its axis. Screw dislocations result when displacing planes relative to each other through shear. Shear stresses are associated with the atoms adjacent to the screw dislocation; therefore extra energy is involved as it is in the case of edge dislocations. Screw dislocation is considered positive if Burger's vector and t -vector or parallel, and vice versa. (t -vector – an unit vector representing the direction of the dislocation line). A positive screw dislocation is represented by “ \odot ” a dot surrounded by circular direction in clock-wise direction”, whereas the negative screw dislocation is represented by “ \ominus ” a dot surrounded by a circular direction in anti-clock-wise direction”. A schematic view of a negative screw dislocation is shown in *figure*.

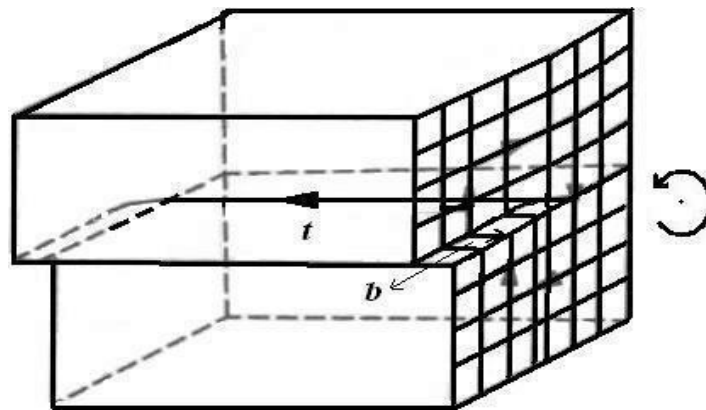

Figure: *Negative screw dislocation.*

A screw dislocation does not have a preferred slip plane, as an edge dislocation has, and thus the motion of a screw dislocation is less restricted than the motion of an Edge dislocation. As there is no preferred slip plane, screw dislocation can cross-slip on to another plane, and can continue its glide under favorable stress conditions. However, screw dislocation can not move by climb process, whereas edge dislocations can not cross-slip.

Dislocations more commonly originate during plastic deformation, during solidification, and as a consequence of thermal stresses that result from rapid cooling. Edge dislocation arises when there is a slight mismatch in the orientation of adjacent parts of the growing crystal. A screw dislocation allows easy crystal growth because additional atoms can be added to the 'step' of the screw. Thus the term screw is apt, because the step swings around the axis as growth proceeds. Unlike point defects, these are not thermodynamically stable. They can be removed by heating to high temperatures where they cancel each other or move out through the crystal to its surface. Virtually all crystalline materials contain some dislocations. The density of dislocations in a crystal is measured by counting the number of points at which they intersect a random cross-section of the crystal. These points, called etch-pits, can be seen under microscope. In an annealed crystal, the dislocation density is the range of $10^8 - 10^{10} \text{ m}^{-2}$.

Any dislocation in a crystal is a combination of edge and screw types, having varying degrees of edge and screw character. *Figure 3.5* depicts a schematic picture of a common dislocation.

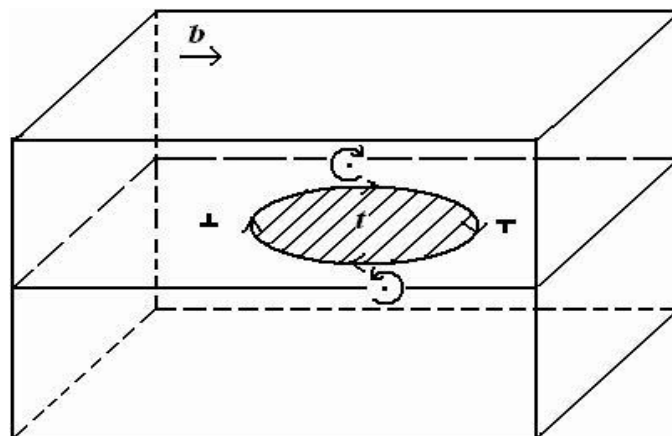

Figure: Typical dislocation in a crystal.

As shown in *figure* , the Burger's vector will have the same magnitude and direction over the whole length of dislocation irrespective of the character of the dislocation (edge, screw,

or mixed) i.e. Burger's vector is invariant. Other geometrical characteristics of dislocations are:

- vectorial sum of Burger's vectors of dislocations meeting at a point, called node, must be zero.

- t-vectors of all the dislocations meeting at a node must either point towards it or away from it.

- a dislocation line can not end abruptly within the crystal. It can close on itself as a loop, or ends either at a node or at the surface.

Dislocations have distortional energy associated with them as is evident from the presence of tensile/compressive/shear stresses around a dislocation line.

Dislocations in the real crystal can be classified into two groups based on their geometry – full dislocations and partial dislocations. Partial dislocation's Burger's vector will be a fraction of a lattice translation, whereas Burger's vector is an integral multiple of a lattice translation for full dislocation. As mentioned above, elastic energy associated with a dislocation is proportional to square of its Burger's vector; dislocation will tend to have as small a Burger's vector as possible. This explains the reason for separation of dislocations that tend to stay away from each other!

Interfacial defects, Bulk or Volume defects and Atomic vibrations

Interfacial defects

Interfacial defects can be defined as boundaries that have two dimensional imperfections in crystalline solids, and have different crystal structures and/or crystallographic orientations on either side of them. They refer to the regions of distortions that lie about a surface having thickness of a few atomic diameters. For example: external surfaces, grain boundaries, twin

boundaries, stacking faults, and phase boundaries. These imperfections are not thermodynamically stable, rather they are meta-stable imperfections. They arise from the clustering of line defects into a plane.

External surface: The environment of an atom at a surface differs from that of an atom in the bulk; especially the number of neighbors (coordination) at surface is less. Thus the unsaturated bonds of surface atoms give rise to a surface energy. This result in *relaxation* (the lattice spacing is decreased) or *reconstruction* (the crystal structure changes). To reduce the energy, materials tend to minimize, if possible, the total surface area.

Grain boundaries: Crystalline solids are, usually, made of number of grains separated by grain boundaries. Grain boundaries are several atoms distances wide, and there is mismatch of orientation of grains on either side of the boundary as shown in *figure-3.6*. When this misalignment is slight, on the order of few degrees ($< 10^\circ$), it is called *low angle grain boundary*. These boundaries can be described in terms of aligned dislocation arrays. If the low grain boundary is formed by edge dislocations, it is called *tilt boundary*, and *twist boundary* if formed of screw dislocations. Both tilt and twist boundaries are planar surface imperfections in contrast to high angle grain boundaries. For *high angle grain boundaries*, degree of disorientation is of large range ($> 15^\circ$). Grain boundaries are chemically more reactive because of grain boundary energy. In spite of disordered orientation of atoms at grain boundaries, polycrystalline solids are still very strong as cohesive forces present within and across the boundary.

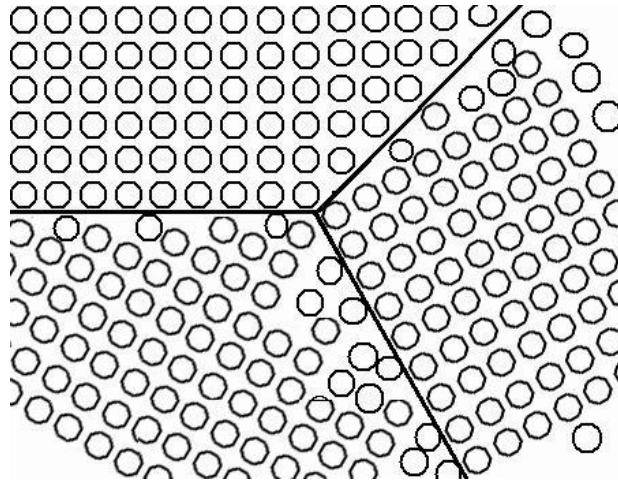

Figure : Schematic presentation of grain boundarie

Twin boundaries: It is a special type of grain boundary across which there is specific mirror lattice symmetry. Twin boundaries occur in pairs such that the orientation change introduced by one boundary is restored by the other (*figure-3.7*). The region between the pair of boundaries is called the twinned region. Twins which forms during the process of recrystallization are called *annealing twins*, whereas *deformation twins* form during plastic deformation. Twinning occurs on a definite crystallographic plane and in a specific direction, both of which depend on the crystal structure. Annealing twins are typically found in metals that have FCC crystal structure (and low stacking fault energy), while mechanical/deformation twins are observed in BCC and HCP metals. Annealing twins are usually broader and with straighter sides than mechanical twins. Twins do not extend beyond a grain boundary.

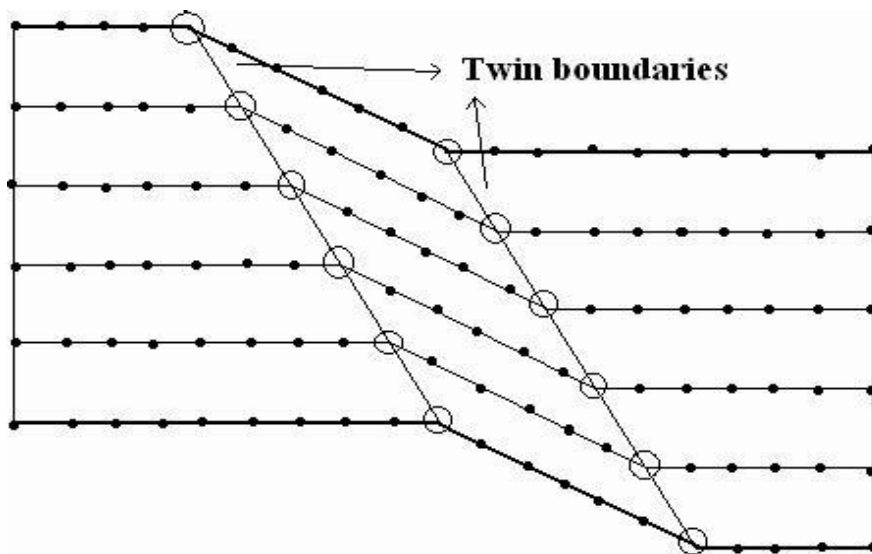

Figure: A pair of twin boundaries.

Stacking faults: They are faults in stacking sequence of atom planes. Stacking sequence in an FCC crystal is ABC ABC ABC ..., and the sequence for HCP crystals is AB AB AB....

When there is disturbance in the stacking sequence, formation of stacking faults takes place. Two kinds of stacking faults in FCC crystals are: (a) ABC AC ABC... where CA CA represent thin HCP region which is nothing but stacking fault in FCC, (b) ABC ACB CABC is called *extrinsic* or *twin stacking fault*. Three layers ACB constitute the twin. Thus stacking faults in FCC crystal can also be considered as submicroscopic twins. This is why no microscopic twins appear in FCC crystals as formation of stacking faults is energetically favorable. Stacking fault energy varies in range $0.01-0.1 \text{ J/m}^2$. Lower the stacking fault energy, wider the stacking fault, metal strain hardens rapidly and twin easily. Otherwise, metals of high stacking fault energy i.e. narrower stacking faults show a deformation structure of banded, linear arrays of dislocations. Phase boundaries exist in multiphase materials across which there is sudden change in physical/chemical characteristics.

d. Bulk or Volume defects

Volume defects as name suggests are defects in 3-dimensions. These include pores, cracks, foreign inclusions and other phases. These defects are normally introduced during processing and fabrication steps. All these defects are capable of acting as stress raisers, and thus deleterious to parent metal's mechanical behavior. However, in some cases foreign

particles are added purposefully to strengthen the parent material. The procedure is called dispersion hardening where foreign particles act as obstacles to movement of dislocations, which facilitates plastic deformation. The second-phase particles act in two distinct ways – particles are either may be cut by the dislocations or the particles resist cutting and dislocations are forced to bypass them. Strengthening due to ordered particles is responsible for the good high-temperature strength on many super-alloys. However, pores are detrimental because they reduce effective load bearing area and act as stress concentration sites.

Atomic vibrations

Atomic vibrations occur, even at zero temperature (a quantum mechanical effect) and increase in amplitude with temperature. In fact, the temperature of a solid is really just a measure of average vibrational activity of atoms and molecules. Vibrations displace *transiently* atoms from their regular lattice site, which destroys the perfect periodicity. In a sense, these atomic vibrations may be thought of as imperfections or defects. At room temperature, a typical vibrational frequency of atoms is of the order of 10^{13} vibrations per second, whereas the amplitude is a few thousandths of a nanometer. Many properties and processes in solids are manifestations of this vibrational atomic motion.

For example: melting occurs once the atomic bonds are overcome by vigorous vibrations.

Module 2

Mechanical Properties of Metals

Most of the materials used in engineering are metallic in nature. The prime reason simply is the versatile nature of their properties those spread over a very broad range compared with other kinds of materials. Many engineering materials are subjected to forces both during processing/fabrication and in service. When a force is applied on a solid material, it may result in translation, rotation, or deformation of that material. Aspects of material translation and rotation are dealt by *engineering dynamics*. We restrict ourselves here to the subject of material deformation under forces. Deformation constitutes both change in shape, *distortion*, and change in size/volume, *dilatation*. Solid material are defined such that change in their volume under applied forces is very small, thus deformation is used as synonymous to distortion. The ability of material to with stand the applied force without any deformation is expressed in two ways, i.e. strength and hardness. Strength is defined in many ways as per the design requirements, while the hardness may be defined as resistance to indentation or scratch.

Material deformation can be permanent *or* temporary. Permanent deformation is irreversible i.e. stays even after removal of the applied forces, while the temporary deformation disappears after removal of the applied forces i.e. the deformation is recoverable. Both kinds of deformation can be function of time, or independent of time. Temporary deformation is called *elastic deformation*, while the permanent deformation is called *plastic deformation*. Time dependent recoverable deformation under load is called *anelastic deformation*, while the characteristic recovery of temporary deformation after removal of load as a function of time is called *elastic aftereffect*. Time dependent i.e. progressive permanent deformation under constant load/stress is called *creep*. For *visco-elastic* materials, both recoverable and permanent deformations occur together which are time dependent. When a material is subjected to applied forces, first the material experiences elastic deformation followed by plastic deformation. Extent of elastic- and plastic- deformations will primarily depend on the kind of material, rate of load application, ambient temperature, among other factors. Change over from elastic state to plastic state is characterized by the yield strength (σ_0) of the material.

Forces applied act on a surface of the material, and thus the force intensity, force per unit area, is used in analysis. Analogous to this, deformation is characterized by percentage change in length per unit length in three distinct directions. Force intensity is also called **engineering stress** (or simply **stress, s**), is given by force divided by area on which the force is acting. **Engineering strain** (or simply **strain, e**) is given by change in length divided by original length. Engineering strain actually indicates an average change in length in a particular direction. According to definition, **s** and **e** are given as

$$s = \frac{P}{A_0}, e = \frac{L - L_0}{L_0}$$

where **P** is the load applied over area **A** , and as a consequence of it material attains the final length **L** from its original length of **L_0** .

Diffusion

Diffusion is the process by which atoms move in a material. Many reactions in solids and liquids are diffusion dependent. Structural control in a solid to achieve the optimum properties is also dependent on the rate of diffusion.

Atoms are able to move throughout solids because they are not stationary but execute rapid, small-amplitude vibrations about their equilibrium positions. Such vibrations increase with temperature and at any temperature a very small fraction of atoms has sufficient amplitude to move from one atomic position to an adjacent one. The fraction of atoms possessing this amplitude increases markedly with rising temperature. In jumping from one equilibrium position to another, an atom passes through a higher energy state since atomic bonds are distorted and broken, and the increase in energy is supplied by thermal vibrations. As might be expected defects, especially vacancies, are quite instrumental in affecting the diffusion process on the type and number of defects that are present, as well as the thermal vibrations of atoms.

Diffusion can be *defined* as the mass flow process in which atoms change their positions relative to neighbors in a given phase under the influence of thermal and a gradient. The gradient can be a compositional gradient, an electric or magnetic gradient, or stress gradient. In this chapter we discuss diffusion because of concentration gradient only.

Diffusion mechanisms, Steady-state and Non-steady-state diffusion *Diffusion mechanisms*

In pure metals self-diffusion occurs where there is no net mass transport, but atoms migrate in a random manner throughout the crystal. In alloys inter-diffusion takes place where the mass transport almost always occurs so as to minimize compositional differences. Various atomic mechanisms for self-diffusion and inter-diffusion have been proposed. *Figure-5.1* presents schematic view of different atomic diffusion mechanisms.

The most energetically favorable process involves an interchange of places by an atom and a neighboring vacancy – *vacancy diffusion*. This process demands not only the motion of vacancies, but also the presence of vacancies. The unit step in vacancy diffusion is an atom breaks its bonds and jumps into neighboring vacant site. In *interstitial diffusion*, solute atoms which are small enough to occupy interstitial sites diffuse by jumping from one interstitial site to another. The unit step here involves jump of the diffusing atom from one interstitial site to a neighboring site. Hydrogen, Carbon, Nitrogen and Oxygen diffuse interstitially in most metals, and the activation energy for diffusion is only that associated with motion since the number of occupied, adjacent interstitial sites usually is large. *Substitutional diffusion* generally proceeds by the vacancy mechanism. Thus interstitial diffusion is faster than substitutional diffusion by the vacancy mechanism. During *self-diffusion* or *ring mechanism* or *direct-exchange mechanism*, three or four atoms in the form of a ring move simultaneously round the ring, thereby interchanging their positions. This mechanism is untenable because exceptionally high activation energy would be required. A *self-interstitial* is more mobile than a vacancy as only small activation energy is required for self-interstitial atom to move to an equilibrium atomic position and simultaneously displace the neighboring atom into an interstitial site. However, the equilibrium number of self-interstitial atoms present at any temperature is negligible in comparison to the number of vacancies. This is because the energy to form a self-interstitial is extremely large.

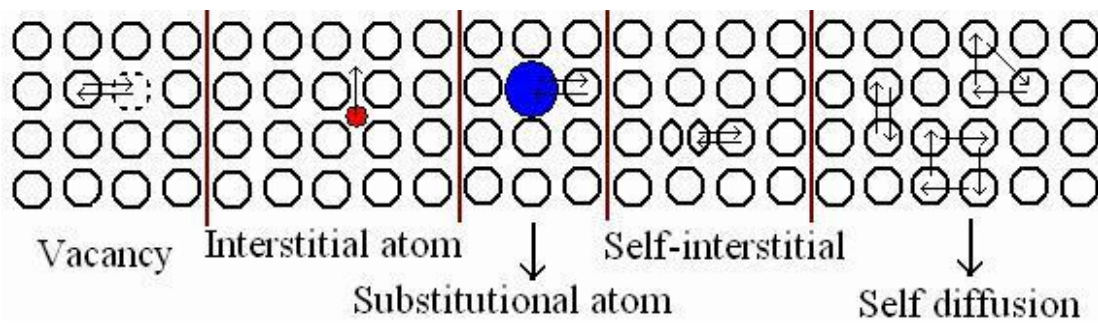

Figure- Diffusion mechanisms.

Diffusion in most ionic solids occurs by a vacancy mechanism. In ionic crystals, Schottky and Frenkel defects assist the diffusion process. When Frenkel defects (pair of vacancy-interstitial) dominate in an ionic crystal, the cation interstitial of the Frenkel defect carries the diffusion flux. If Schottky defects (pair of vacant sites) dominate, the cation vacancy carries the diffusion flux. In thermal equilibrium, in addition to above defects, ionic crystal may have defects generated by impurities and by deviation from stoichiometry. Thus imperfections in ionic materials that influence diffusion arise in two ways: (1) intrinsic point defects such as Frenkel and schottky defects whose number depends on temperature, and (2) extrinsic point defects whose presence is due to impurity ions of different valance than the host ions. The former is responsible for temperature dependence of diffusion similar to that for self-diffusion in metals, while the latter result in a temperature dependence of diffusion which is similar to that for interstitial solute diffusion in metals.

For example: Cd^{+2} cation in NaCl crystal will results in a cation vacancy. As Schottky defects form easily in NaCl crystal and thus cation vacancies carry the diffusion flux, even small fraction of Cd^{+2} increases the diffusivity of NaCl by several orders. Excess Zn^{+2} interstitials present in a non-stoichiometric ZnO compound increase the diffusivity of Zn^{+2} ions significantly. It is same with non-stoichiometric FeO.

In addition to diffusion through the bulk of a solid (volume diffusion), atoms may migrate along external or internal paths that afford lower energy barriers to motion. Thus diffusion can occur along dislocations, grain boundaries or external surfaces. The rates of diffusion along such *short-circuit paths* are significantly higher than for volume

diffusion. However, most cases of mass transport are due to volume diffusion because the effective cross-sectional areas available for short-circuit processes are much smaller than those for volume diffusion.

There is a difference between diffusion and net diffusion. In a homogeneous material, atoms also diffuse but this motion is hard to detect. This is because atoms move randomly and there will be an equal number of atoms moving in one direction than in another. In inhomogeneous materials, the effect of diffusion is readily seen by a change in concentration with time. In this case there is a *net* diffusion. Net diffusion occurs because, although all atoms are moving randomly, there are more atoms moving away from regions where their concentration is higher.

Steady-state diffusion

Diffusional processes can be either steady-state or non-steady-state. These two types of diffusion processes are distinguished by use of a parameter called flux. It is defined as net number of atoms crossing a unit area perpendicular to a given direction per unit time. For steady-state diffusion, flux is constant with time, whereas for non-steady-state diffusion, flux varies with time. A schematic view of concentration gradient with distance for both steady-state and non-steady-state diffusion processes are shown in *figure*.

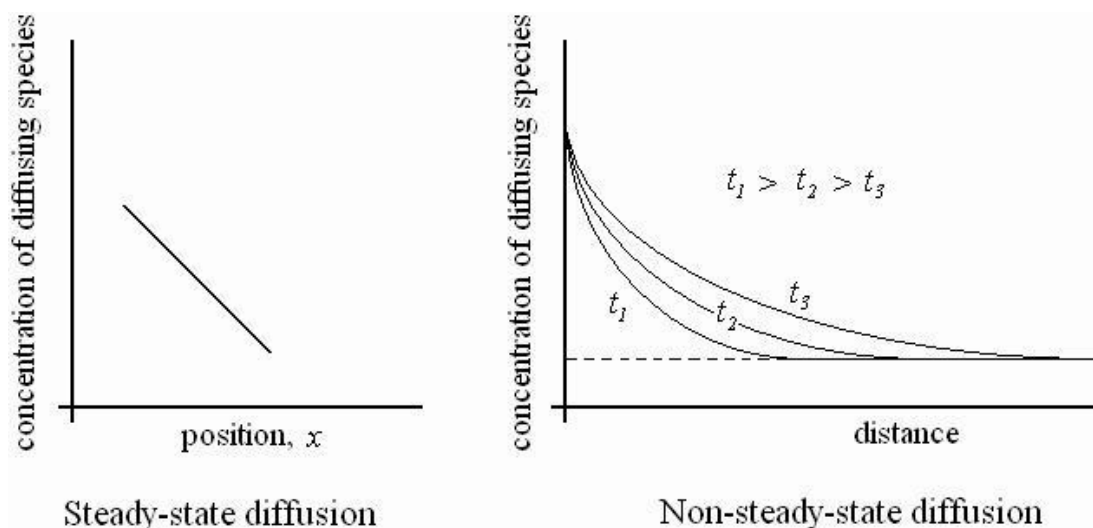

Figure: *Steady-state and Non-steady-state diffusion processes.*

Non-equilibrium transformation & microstructure

During the processing of metallic materials, they are subjected to different conditions and thus transformation of its structure. During casting process, liquid metal is allowed to cool to become solid component. However, during cooling conditions can be such that they are in equilibrium or non-equilibrium state. Phases and corresponding microstructures, usually shown in a phase diagram, are generated during equilibrium solidification under the conditions that are realized only for extremely slow cooling rates. This is because with change in temperature, there must be readjustments in the compositions of liquids and solid phases in accordance with the phase diagram. These readjustments are accomplished by diffusional processes in both solid and liquid phases and also across the solid-liquid interface. But, it is well understood that diffusion is time- dependent phenomenon, and moreover diffusion in solid phases are much lower than in liquid phases, equilibrium solidification requires extremely longer times those are impractical. Thus virtually all practical solidification takes place under non-equilibrium conditions, leading to compositional gradients and formation of meta-stable phases.

As a consequence of compositional gradients during non-equilibrium cooling, segregation (concentration of particular, usually impurity elements, along places like grain boundaries) and coring (gradual compositional changes across individual grains) may occur. Coring is predominantly observed in alloys having a marked difference between liquidus and solidus temperatures. It is often being removed by subsequent annealing (incubation at relatively high temperatures that are close to lower solidus temperature, enhances diffusion in solids) and/or hot-working, and is exploited in zone- refining technique to produce high-purity metals. Segregation is also put to good use in zone refining, and also in the production of rimming steel. Micro-segregation is used to describe the differences in composition across a crystal or between neighboring crystals. On the other hand, macro-segregation is used to describe more massive heterogeneities which may result from entrapment of liquid pockets between growing solidifying zones. Micro-segregation can often be removed by prolonged annealing or by hot-working; but macro-segregation persists through normal heating and working operations.

In most situations cooling rates for equilibrium solidification are impractically slow and unnecessary; in fact, on many occasions non-equilibrium conditions are desirable. Two non

equilibrium effects of practical importance are (1) the occurrence of phase changes or transformations at temperatures other than those predicted by phase boundary lines on the phase diagram, and (2) the existence of non-equilibrium phases at room temperature that do not appear on the phase diagram. These will be detailed in next chapters about phase transformation.

Dislocations and Strengthening Mechanisms

Dislocations & Plastic deformation and Mechanisms of plastic deformation in metals

Dislocations & Plastic deformation

While some materials are elastic in nature up point of fracture, many engineering materials like metals and thermo-plastic polymers can undergo substantial permanent deformation. This characteristic property of materials makes it feasible to shape them. However, it imposes some limitations on the engineering usefulness of such materials. Permanent deformation is due to process of shear where particles change their neighbors. During this process inter-atomic or inter-molecular forces and structure plays important roles, although the former are much less significant than they are in elastic behavior. Permanent deformation is broadly two types – plastic deformation and viscous flow. Plastic deformation involves the relative sliding of atomic planes in organized manner in crystalline solids, while the viscous flow involves the switching of neighbors with much more freedom that does not exist in crystalline solids.

It is well known that dislocations can move under applied external stresses. Cumulative movement of dislocations leads to the gross plastic deformation. At microscopic level, dislocation motion involves rupture and reformation of inter-atomic bonds. The necessity of dislocation motion for ease of plastic deformation is well explained by the discrepancy between theoretical strength and real strength of solids, as explained in chapter-3. It has been concluded that one-dimensional crystal defects – dislocations – plays an important role in plastic deformation of crystalline solids. Their importance in plastic deformation is relevant to their characteristic nature of motion in specific directions (slip-directions) on specific planes (slip-planes), where edge dislocation move by slip and climb while screw dislocation can be moved by slip and cross-slip.

The onset of plastic deformation involves start of motion of existing dislocations in real crystal, while in perfect crystal it can be attributed to generation of dislocations and subsequently their motion. During the motion, dislocations will tend to interact among themselves. Dislocation interaction is very complex as number of dislocations moving on number of slip planes in various directions. When they are in the same plane, they repel each other if they have the same sign, and annihilate if they have opposite signs (leaving behind a perfect crystal). In general, when dislocations are close and their strain fields add to a larger value, they repel, because being close increases the potential energy (it takes energy to strain a region of the material). When unlike dislocations are on closely spaced neighboring slip planes, complete annihilation cannot occur. In this situation, they combine to form a row of vacancies *OR* an interstitial atom.

An important consequence interaction of dislocations that are not on parallel planes is that they intersect each other or inhibit each others motion. Intersection of two dislocations results in a sharp break in the dislocation line. These breaks can be of two kinds:

- (a) A jog is break in dislocation line moving it out of slip plane.
- (b) A kink is break in dislocation line that remains in slip plane.

Other hindrances to dislocation motion include interstitial and substitutional atoms, foreign particles, grain boundaries, external grain surface, and change in structure due to phase change. Important practical consequences of hindrance of dislocation motion are that dislocations are still movable but at higher stresses (or forces), and in most instances that leads to generation of more dislocations. Dislocations can spawn from existing dislocations, and from defects, grain boundaries and surface irregularities. Thus, the number of dislocations increases dramatically during plastic deformation. As further motion of dislocations requires increase of stress, material can be said to be strengthened i.e. materials can be strengthened by controlling the motion of dislocation.

Mechanisms of plastic deformation in metals

Plastic deformation, as explained in earlier section, involves motion of dislocations.

There are two prominent mechanisms of plastic deformation, namely ***slip*** and ***twinning***.

Slip is the prominent mechanism of plastic deformation in metals. It involves sliding of blocks of crystal over one other along definite crystallographic planes, called slip planes. In physical words it is analogous to a deck of cards when it is pushed from one end. Slip occurs when shear stress applied exceeds a critical value. During slip each atom usually moves same integral number of atomic distances along the slip plane producing a step, but the orientation of the crystal remains the same. Steps observable under microscope as straight lines are called slip lines.

Slip occurs most readily in specific directions (slip directions) on certain crystallographic planes. This is due to limitations imposed by the fact that single crystal remains homogeneous after deformation. Generally slip plane is the plane of greatest atomic density, and the slip direction is the close packed direction within the slip plane. It turns out that the planes of the highest atomic density are the most widely spaced planes, while the close packed directions have the smallest translation distance. Feasible combination of a slip plane together with a slip direction is considered as a slip system.

The common slip systems are given in *table*.

Table-: *Slip systems for different crystal structures.*

Crystal	Occurrence	Slip planes	Slip directions
FCC		{111}	<110>
BCC	More common	{110}	<111>
	Less common	{112}, {123}	
HCP	More common	Basal plane	Close packed directions
	Less common	Prismatic & Pyramidal planes	
NaCl		{110}	<110>

Slip in polycrystalline material involves generation, movement and (re-)arrangement of dislocations. Because of dislocation motion on different planes in various directions, they may interact as well. This interaction can cause dislocation immobile or mobile at higher stresses. During deformation, mechanical integrity and coherency are maintained along the grain boundaries; that is, the grain boundaries are constrained, to some degree, in the shape it may assume by its neighboring grains. Once the yielding has occurred, continued plastic deformation is possible only if enough slip systems are simultaneously operative so as to accommodate grain shape changes while maintaining grain boundary integrity.

According to von Mises criterion, a minimum of five independent slip systems must be operative for a polycrystalline solid to exhibit ductility and maintain grain boundary integrity. This arises from the fact that an arbitrary deformation is specified by the six components of strain tensor, but because of requirement of constant volume, there are only independent strain components. Crystals which do not possess five independent slip systems are never ductile in polycrystalline form, although small plastic elongation may be noticeable because of twinning or a favorable preferred orientation.

The second important mechanism of plastic deformation is twinning. It results when a portion of crystal takes up an orientation that is related to the orientation of the rest of the untwined lattice in a definite, symmetrical way. The twinned portion of the crystal is a mirror image of the parent crystal. The plane of symmetry is called twinning plane. Each atom in the twinned region moves by a homogeneous shear a distance proportional to its distance from the twin plane. The lattice strains involved in twinning are small, usually in order of fraction of inter-atomic distance, thus resulting in very small gross plastic deformation. The important role of twinning in plastic deformation is that it causes changes in plane orientation so that further slip can occur. If the surface is polished, the twin would be still visible after etching because it possesses a different orientation from the untwined region. This is in contrast with slip, where slip lines can be removed by polishing the specimen.

Twinning also occurs in a definite direction on a specific plane for each crystal structure. However, it is not known if there exists resolved shear stress for twinning. Twinning generally occurs when slip is restricted, because the stress necessary for twinning is usually higher than that for slip. Thus, some HCP metals with limited number of slip systems may preferably twin. Also, BCC metals twin at low temperatures because slip is difficult. Of course, twinning and slip may occur sequentially or even concurrently in some cases. Twinning systems for some metals are given in table.

Table-: *Twin systems for different crystal structures.*

Crystal	Example	Twin plane	Twin direction
FCC	Ag, Au, Cu	(111)	[112]
BCC	α -Fe, Ta	(112)	[111]
HCP	Zn, Cd, Mg, Ti	(10 $\bar{1}$ 2)	[$\bar{1}$ 1011]

Figure- presents schematic movement of atoms during plastic deformation in slip and during twinning.

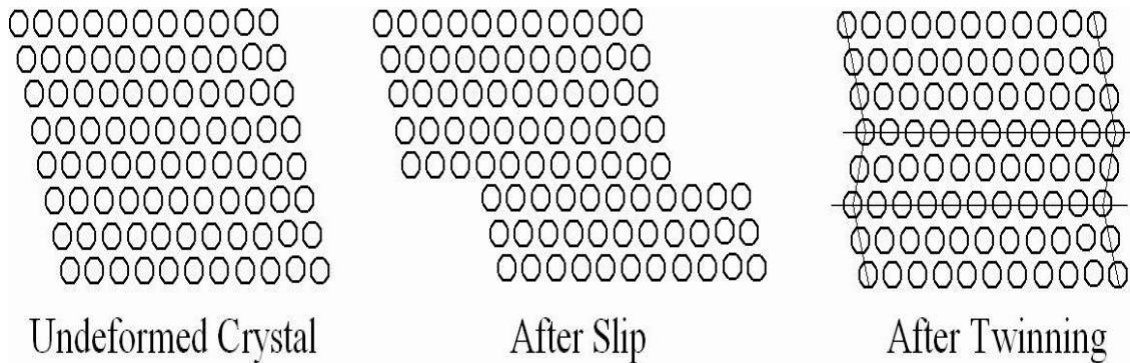

Figure-: Schematic presentation of different plastic deformation mechanism.

In **table-**, both the mechanisms of plastic deformations are compared with respect to their characteristics.

Table-: Comparison of mechanism of plastic deformation.

	during/in slip	during/in twinning
Crystal orientation	Same above and below the slip plane	Differ across the twin plane
Size (in terms of inter-atomic distance)	Multiples	Fractions
Occurs on	Widely spread planes	Every plane of region involved
Time required	Milli seconds	Micro seconds
Occurrence	On many slip systems simultaneously	On a particular plane for each crystal

Strengthening mechanisms in Metals

Ability of a metal to deform plastically depends on ease of dislocation motion under applied external stresses. As mentioned in earlier section, strengthening of a metal consist hindering dislocation motion. Dislocation motion can be hindered in many ways, thus are strengthening mechanisms in metals. Strengthening by methods of grain-size reduction, solid-solution alloying and strain hardening applies for single-phase metals. Precipitation hardening, dispersion hardening, fiber strengthening and Martensite strengthening are applicable to multi-phase metallic materials.

Strengthening by Grain Size Reduction

This strengthening mechanism is based on the fact that crystallographic orientation changes abruptly in passing from one grain to the next across the grain boundary. Thus it is difficult for a dislocation moving on a common slip plane in one crystal to pass over to a similar slip plane in another grain, especially if the orientation is very misaligned. In addition, the crystals are separated by a thin non-crystalline region, which is the characteristic structure of a large angle grain boundary. Atomic disorder at the boundary causes discontinuity in slip planes. Hence dislocations are stopped by a grain boundary and pile up against it. The smaller the grain size, the more frequent is the pile up of dislocations. A twin boundary can also act as an obstacle to dislocation motion.

A grain boundary can hinder the dislocation motion in two ways: (1) by forcing the dislocation to change its direction of motion and (2) discontinuity of slip plane because of disorder. Effectiveness of grain boundary depends on its characteristic misalignment, represented by an angle. The ordinary high-angle grain boundary (misalignment $> 5^\circ$) represents a region of random misfit between the grains on each side of the boundary. This structure contains grain-boundary dislocations which are immobile. However they group together within the boundary to form a step or grain boundary ledge. These ledges can act as effective sources of dislocations as the stress at end of slip plane may trigger new dislocations in adjacent grains. Small angle grain boundaries (misalignment $< 1^\circ$) are considered to be composed of a regular array of dislocations, and are not effective in blocking dislocations.

With decrease in grain size, the mean distance of a dislocation can travel decreases, and soon starts pile up of dislocations at grain boundaries. This leads to increase in yield strength of the material. E.O.Hall and N.J.Petch have derived the following relation, famously known as *Hall-Petch relation*, between yield strength (σ_y) and grain size (d):

Solid Solution Strengthening

Adding atoms of another element that those occupy interstitial or substitutional positions in parent lattice increases the strength of parent material. This is because stress fields generated around the solute atoms interact with the stress fields of a moving dislocation, thereby

increasing the stress required for plastic deformation i.e. the impurity atoms cause lattice strain which can "anchor" dislocations. This occurs when the strain caused by the alloying element compensates that of the dislocation, thus achieving a state of low potential energy. Since solid-solution alloy additions affect the entire stress-strain curve, it can be said that solute atoms have more influence on the frictional resistance to dislocation motion than on the static locking of dislocations. Pure metals are almost always softer than their alloys. Solute strengthening effectiveness depends on two factors

– size difference between solute and parent atoms, and concentration of solute atoms.

Solute atoms are two categories with respect to their relative strengthening effect – (1) those produce non-spherical distortions, such as most interstitial atoms, have a relative strengthening effect per unit concentration of about three times their shear modulus, (2) those produce spherical distortion, such as substitutional atoms, have a relative strengthening of about $G/10$.

Solute atoms interact with dislocations in many ways, namely: elastic interaction; modulus interaction; stacking-fault interaction; electrical interaction; short-range order interaction; and long-range order interaction. Elastic, modulus, and long-range order interactions are of long-range i.e. they are relatively insensitive to temperature and continue to act about $0.6 T_m$ where T_m is the melting temperature in absolute Kelvin degrees.

Elastic interaction results from mutual interaction of elastic stress fields, while *modulus interaction* occurs if the presence of a solute atom locally alters the modulus of the crystal.

Stacking-fault interactions arise because solute atoms may segregate to the

stacking-faults, thus lowering stacking-fault energy and widening partial dislocations. This interaction is also called as Suzuki or Chemical interaction. *Electrical interaction* arises if solute atoms of dissimilar valence interact with dislocations which have electrical dipoles. *Short-range order interaction* arises from the tendency for solute atoms to arrange themselves so that they have more than the equilibrium number of dissimilar neighbors. The opposite of short-range order is clustering. *Long-range order interaction* arises in alloys which form super-lattices, in which long-range periodic arrangement of dissimilar atoms gets disturbed, to form anti-phase boundaries, because of dislocation motion which leads to dissociation of dislocation into pairs of ordinary dislocations.

Some polycrystalline metals, such as mild steel, display a discrete yield point type of behavior where a higher stress is necessary to initiate plastic flow than to continue it. Thus, there exists a localized, heterogeneous type of transition from elastic to plastic deformation which produces a yield point in the stress-strain curve i.e. elastic-plastic transition is very well demarked and occurs abruptly in what is called yield-point phenomenon. During loading the load increases steadily with elastic strain, drops suddenly at the upper yield point where plastic deformation gets initiated. Continued deformation fluctuates slightly about some constant stress value – lower yield point. Subsequently stress increase with increasing strain. Elongation that occurs at constant load is called the yield-point elongation. Yield strength for metals with this phenomenon is taken as average of lower yield point, thus it is not necessary to employ strain offset method. A schematic picture in *figure* presents the exaggerated version of yield-point phenomenon.

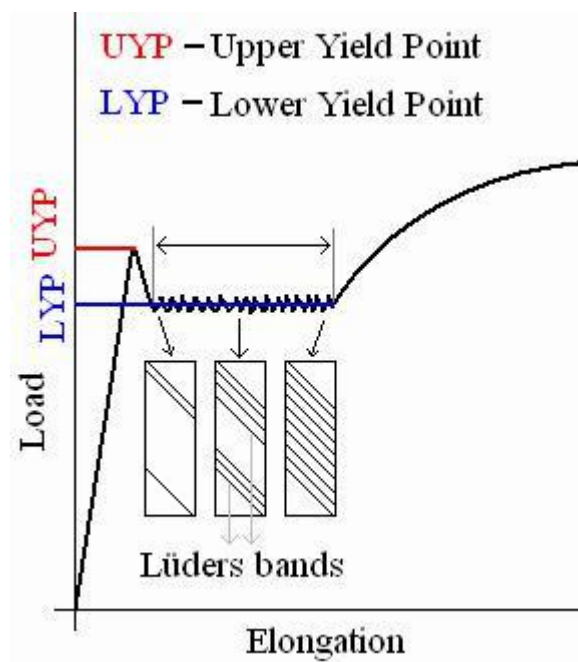

Figure- Yield point phenomenon

At the upper yield point, deformed part of metal forms a discrete band usually visible to eye at a stress concentration. Many bands may form at the same time at different stress concentration sites. Each band then propagates along the length of the specimen, causing yield-point elongation. These bands are called Lüders bands / Hartmann lines / stretcher stains, and generally are approximately 45° to the tensile axis. Occurrence of yield point is associated with presence of small amounts of interstitial or substitutional impurities. It's been

found that either unlocking of dislocations by a high stress for the case of strong pinning or generation of new dislocations are the reasons for yield-point phenomenon. Thus when the dislocation line is pulled free from the influence of solute atoms, slip can occur at a lower stress. On the other hand, when dislocations are strongly pinned, new dislocations will generate followed by drop in flow stress. This is the origin of upper yield stress. Released dislocations tend to pile-up at grain boundaries, producing stress concentration which in addition to applied stress unlocks sources in next grain. This is the way band propagates. Magnitude of yield-point effect will depend on energy of interaction between solute atoms and dislocations and on the concentration of solute atoms at the dislocations.

Strain Hardening

Two most important industrial processes used to harden metals or alloys are: strain hardening and heat treatment. Strain hardening is used for hardening/strengthening materials that are not responsive to heat treatment. The phenomenon where ductile metals become stronger and harder when they are deformed plastically is called strain hardening *or* work hardening.

Intensity of strain hardening can be gaged from the slope of the flow curve, defined by the parameter strain hardening exponent, n . It is measure of the ability of a metal to strain harden. For a given amount of plastic strain, higher the value of n , greater is the strain hardening. Increasing temperature lowers the rate of strain hardening, and thus the treatment is given, usually, at temperatures well below the melting point of the material. Thus the treatment is also known as *cold working*. Most metals strain hardens at room temperature. The consequence of strain hardening a material is improved strength and hardness but material's ductility will be reduced.

Recovery, Recrystallization and Grain Growth

As mentioned in earlier sections, annealing is an important industrial process to relieve the stresses from cold working. During cold working grain shape changes, while material strain hardens because of increase in dislocation density. Between 1-10% of the energy of plastic deformation is stored in material in the form of strain energy associated with point defects and dislocations. On annealing i.e. on heating the deformed material to higher temperatures and holding, material tends to lose the extra strain energy and revert to the original condition before deformation by the processes of recovery and recrystallization. Grain growth may follow these in some instances.

Recovery

This is the first stage of restoration after cold working where physical properties of the cold-worked material are restored without any observable change in microstructure. The properties that are mostly affected by recovery are those sensitive to point defects, for example – thermal and electrical conductivities. During recovery, which takes place at low temperatures of annealing, some of the stored internal energy is relieved by virtue of dislocation motion as a result of enhanced atomic diffusion. There is some reduction, though not substantial, in dislocation density as well as apart from formation of dislocation configurations with low strain energies. Excess point defects that are created during deformation are annihilated either by absorption at grain boundaries or dislocation climbing process. Stored energy of cold work is the driving force for recovery.

Recrystallization

This stage of annealing follows after recovery stage. Here also driving force is stored energy of cold work. Even after complete recovery, the grains are still in relatively high strain energy state. This stage, thus, involves replacement of cold-worked structure by a new set of strain-free, approximately equi-axed grains i.e. it is the process of nucleation and growth of new, strain-free crystals to replace all the deformed crystals. It starts on heating to temperatures in the range of 0.3-0.5 T_m , which is above the recovery stage. There is no crystal structure change during recrystallization. This process is characterized by recrystallization temperature which is defined as the temperature at which 50% of material recrystallizes in one hour time. The recrystallization temperature is strongly dependent on the purity of a

material. Pure materials may recrystallizes around $0.3 T_m$, while impure materials may recrystallizes around $0.5-0.7 T_m$.

There are many variables that influence recrystallization behavior, namely amount of prior deformation, temperature, time, initial grain size, composition and amount of recovery prior to the start of the recrystallization. This dependence leads to following empirical laws:

- A minimum amount of deformation is needed to cause recrystallization.
- Smaller the degree of deformation, higher will be the recrystallization temperature.
- The finer is the initial grain size; lower will be the recrystallization temperature.
- The larger the initial grain size, the greater degree of deformation is required to produce an equivalent recrystallization temperature.
- Greater the degree of deformation and lower the annealing temperature, the smaller will be the recrystallized grain size.
- The higher is the temperature of cold working, the less is the strain energy stored and thus recrystallization temperature is correspondingly higher.
- The recrystallization rate increases exponentially with temperature.

During recrystallization, the mechanical properties that were changes during deformation are restored to their pre-cold-work values. Thus material becomes softer, weaker and ductile. During this stage of annealing impurity atoms tend to segregate at grain boundaries, and retard their motion and obstruct the processes of nucleation and growth. This *solute drag effect* can be used to retain cold worked strength at higher service temperatures. Presence of second phase particles causes slowing down of recrystallization – *pinning action of the particles*.

Grain growth

This stage follows complete crystallization if the material is left at elevated temperatures. However, grain growth does not need to be preceded by recovery and recrystallization; it may occur in all polycrystalline materials. During this stage newly formed strain-free grains tend to grow in size. This grain growth occurs by the migration of grain boundaries. Driving force for this process is reduction in grain boundary energy i.e. decreasing in free

energy of the material. As the grains grow larger, the curvature of the boundaries becomes less. This results in a tendency for larger grains to grow at the expense of smaller grains. In practical applications, grain growth is not desirable. Incorporation of impurity atoms and insoluble second phase particles are effective in retarding grain growth.

Because the driving force for grain growth is lower than the driving force for recrystallization, grain growth occurs slowly at a temperature where recrystallization occurs at substantially high speeds. However, grain growth is strongly temperature dependent.

Module 3

Phase Diagrams

Many of the engineering materials possess mixtures of phases, e.g. steel, paints, and composites. The mixture of two or more phases may permit interaction between different phases, and results in properties usually are different from the properties of individual phases. Different components can be combined into a single material by means of solutions or mixtures. *A solution (liquid or solid) is phase with more than one component; a mixture is a material with more than one phase.* Solute does not change the structural pattern of the solvent, and the composition of any solution can be varied. In mixtures, there are different phases, each with its own atomic arrangement. It is possible to have a mixture of two different solutions!

A pure substance, under equilibrium conditions, may exist as either of a phase namely vapor, liquid or solid, depending upon the conditions of temperature and pressure. A *phase* can be defined as a homogeneous portion of a system that has uniform physical and chemical characteristics i.e. it is a physically distinct from other phases, chemically homogeneous and mechanically separable portion of a system. In other words, a phase is a structurally homogeneous portion of matter. When two phases are present in a system, it is not necessary that there be a difference in both physical and chemical properties; a disparity in one or the other set of properties is sufficient.

There is only one vapor phase no matter how many constituents make it up. For pure substance there is only one liquid phase, however there may be more than one solid phase because of differences in crystal structure. A liquid solution is also a single phase, even as a liquid mixture (e.g. oil and water) forms two phases as there is no mixing at the molecular level. In the solid state, different chemical compositions and/or crystal structures are possible so a solid may consist of several phases. For the same composition, different crystal structures represent different phases. A solid solution has atoms mixed at atomic level thus it represents a single phase. A single-phase system is termed as homogeneous, and systems composed of two or more phases are termed as mixtures or heterogeneous. Most of the alloy systems and composites are heterogeneous.

It is important to understand the existence of phases under various practical conditions

which may dictate the microstructure of an alloy, thus the mechanical properties and usefulness of it. Phase diagrams provide a convenient way of representing which state of aggregation (phase or phases) is stable for a particular set of conditions. In addition, phase diagrams provide valuable information about melting, casting, crystallization, and other phenomena.

Useful terminology:-

Component – is either pure metal and/or compounds of which an alloy is composed. The components of a system may be elements, ions or compounds. They refer to the independent chemical species that comprise the system.

System – it can either refer to a specific body of material under consideration or it may relate to the series of possible alloys consisting of the same components but without regard to alloy composition.

Solid solution – it consists of atoms of at least two different types where solute atoms occupy either substitutional or interstitial positions in the solvent lattice and the crystal structure of the solvent is maintained.

Solubility limit – for almost all alloy systems, at a specific temperature, a maximum of solute atoms can dissolve in solvent phase to form a solid solution. The limit is known as solubility limit. In general, solubility limit changes with temperature. If solute available is more than the solubility limit that may lead to formation of different phase, either a solid solution or compound.

Phase equilibrium – it refers to the set of conditions where more than one phase may exist. It can be reflected by constancy with time in the phase characteristics of a system. In most metallurgical and materials systems, phase equilibrium involves just solid phases. However the state of equilibrium is never completely achieved because of very slow rate of approach of equilibrium in solid systems. This leads to non-equilibrium or meta-stable state, which may persist indefinitely and of course, has more practical significance than equilibrium phases. An equilibrium state of solid system can be reflected in terms of

characteristics of the microstructure, phases present and their compositions, relative phase amounts and their spatial arrangement or distribution.

Variables of a system – these include two external variables namely temperature and pressure along with internal variable such as composition (C) and number of phases (P). Number of independent variables among these gives the degrees of freedom (F) or variance. All these are related for a chosen system as follows:

$$P+F=C+2$$

which is known as *Gibbs Phase rule*. The degrees of freedom cannot be less than zero so that we have an upper limit to the number of phases that can exist in equilibrium for a given system. For practical purpose, in metallurgical and materials field, pressure can be considered as a constant, and thus the *condensed phase rule* is given as follows:

$$P+F=C+1$$

Equilibrium Phase Diagrams, Particle strengthening by precipitation and precipitation reactions

Equilibrium Phase Diagrams

A diagram that depicts existence of different phases of a system under equilibrium is termed as *phase diagram*. It is also known as *equilibrium* or *constitutional diagram*. Equilibrium phase diagrams represent the relationships between temperature and the compositions and the quantities of phases at equilibrium. In general practice it is sufficient to consider only solid and liquid phases, thus pressure is assumed to be constant (1 *atm.*) in most applications. These diagrams do not indicate the dynamics when one phase transforms into another. However, it depicts information related to microstructure and phase structure of a particular system in a convenient and concise manner. Important information, useful for the scientists and engineers who are involved with materials development, selection, and application in product design, obtainable from a phase diagram can be summarized as follows:

- To show phases are present at different compositions and temperatures under

slow cooling (equilibrium) conditions.

- To indicate equilibrium solid solubility of one element/compound in another.
- To indicate temperature at which an alloy starts to solidify and the range of solidification.
- To indicate the temperature at which different phases start to melt.
- Amount of each phase in a two-phase mixture can be obtained.

A phase diagram is actually a collection of solubility limit curves. The phase fields in equilibrium diagrams depend on the particular systems being depicted. Set of solubility curves that represents locus of temperatures above which all compositions are liquid are called *liquidus*, while *solidus* represents set of solubility curves that denotes the locus of temperatures below which all compositions are solid. Every phase diagram for two or more components must show a liquidus and a solidus, and an intervening freezing range, except for pure system, as melting of a phase occurs over a range of temperature. Whether the components are metals or nonmetals, there are certain locations on the phase diagram where the liquidus and solidus meet. For a pure component, a contact point lies at the edge of the diagram. The liquidus and solidus also meet at the other invariant positions on the diagram. Each invariant point represents an invariant reaction that can occur only under a particular set of conditions between particular phases, so is the name for it!

Phase diagrams are classified based on the number of components in the system. Single component systems have unary diagrams, two-component systems have binary diagrams, three-component systems are represented by ternary diagrams, and so on. When more than two components are present, phase diagrams become extremely complicated and difficult to represent. This chapter deals mostly with binary phase diagrams.

Unary diagrams:

In these systems there is no composition change ($C=1$), thus only variables are temperature and pressure. Thus in region of single phase two variables (temperature and pressure) can be varied independently. If two phases coexist then, according to Phase rule, either temperature or pressure can be varied independently, but not both. At triple points, three phases can coexist at a particular set of temperature and pressure. At these points, neither temperature nor the pressure can be changed without disrupting the equilibrium i.e. one of the phases may

disappear. *Figure-* depicts phase diagram for water.

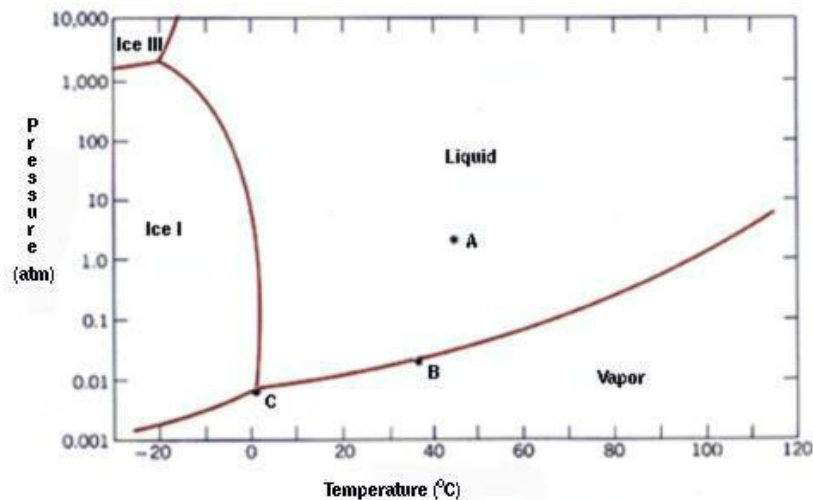

Figure-: Unary phase diagram for water.

Binary diagrams:

These diagrams constitute two components, e.g.: two metals (Cu and Ni), or a metal and a compound (Fe and Fe₃C), or two compounds (Al₂O₃ and Si₂O₃), etc. In most engineering applications, as mentioned before, condensed phase rule is applicable. It is assumed that the same is applicable for all binary diagrams, thus the presentation of binary diagrams becomes less complicated. Thus binary diagrams are usually drawn showing variations in temperature and composition only. It is also to be noted that all binary systems consist only one liquid phase i.e. a component is completely soluble in the other component when both are in liquid state.

Hence, binary systems are classified according to their solid solubility. If both the components are completely soluble in each other, the system is called *isomorphous* system. E.g.: Cu-Ni, Ag-Au, Ge-Si, Al₂O₃-Cr₂O₃. Extent solid solubility for a system of two metallic components can be predicted based on Hume-Ruthery conditions, summarized in the following:

- Crystal structure of each element of solid solution must be the same.
- Size of atoms of each two elements must not differ by more than 15%.
- Elements should not form compounds with each other i.e. there should be no

appreciable difference in the electro-negativities of the two elements.

- Elements should have the same valence.

All the Hume-Rothery rules are not always applicable for all pairs of elements which show complete solid solubility.

In systems other than isomorphous systems i.e. in case of limited solid solubility, there exist solid state miscibility gaps; number of invariant reactions can take place; intermediate phases may exist over a range of composition (*intermediate solid solutions*) or only at relatively fixed composition (*compound*). These intermediate phases may undergo polymorphic transformations, and some may melt at a fixed temperature (*congruent transformations*, in which one phase changes to another of the same composition at definite temperature). A solid solution based on a pure component and extending to certain finite compositions into a binary phase diagram is called a *terminal solid solution*, and the line representing the solubility limit of a terminal solid solution *w.r.t* a two-phase solid region is called a *solvus* line (*figure-4*).

Isomorphous system:

Figure depicts a typical phase diagram for an isomorphous system made of two metallic elements **A** and **B**. As cited earlier, any phase diagram can be considered as a map. A set of coordinates – a temperature and a composition – is associated with each point in the diagram. If the alloy composition and temperature specified, then the phase diagram allows determination of the phase or phases that will present under equilibrium conditions. There are only two phases in the phase diagram, the liquid and the solid phases. These single-phases regions are separated by a two-phase region where both liquid and solid co-exist. The area in the *figure-2* above the line marked liquidus (**A'bB'**) corresponds to the region of stability of the liquid phase, and the area below the solidus line (**A'dB'**) represents the stable region for the solid phase.

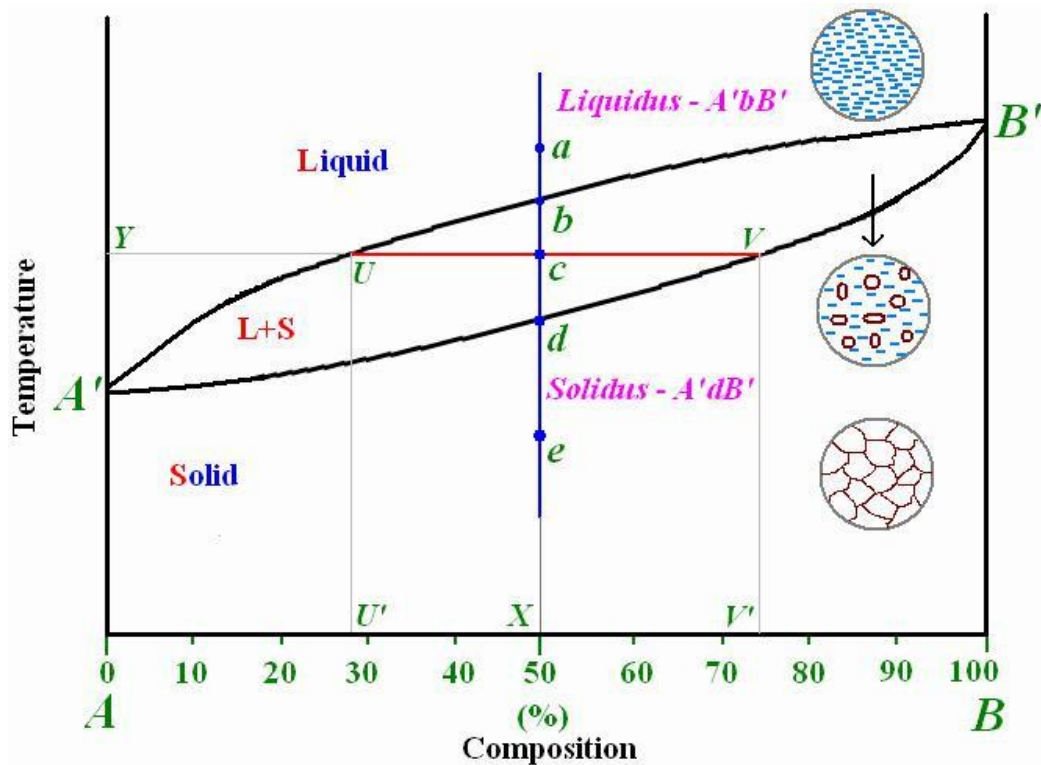

Figure-: Phase diagram for typical isomorphous binary system.

For the interpretation of the phase diagram, let's consider the vertical line **ae** drawn corresponding to composition of 50%**A** +50%**B** and assume that the system is undergoing equilibrium cooling. The point **a** on the line **ae** signifies that for that particular temperature and composition, only liquid phase is stable. This is true up to the point **b** which lies on the liquidus line, representing the starting of solidification. Completion of solidification of the alloy is represented by the point, **d**. Point **e** corresponds to single- phase solid region up to the room temperature. Point **c** lies in the two-phase region made of both liquid and solid phases. Corresponding micro-structural changes are also shown in *figure-2*. As shown in *figure-2*, above liquidus only a liquid phase exists, and below the solidus single solid phase exists as completely solidified grains. Between these two lines, system consist both solid crystals spread in liquid phase. It is customary to use **L** to represent liquid phase(s) and Greek alphabets (α , β , γ) for representing solid phases.

Between two extremes of the horizontal axis of the diagram, cooling curves for different alloys are shown in *figure* as a function of time and temperature. Cooling curves shown in *figure-3* represent **A**, **U'**, **X**, **V'** and **B** correspondingly in *figure-2*. Change in slope of the

cooling curve is caused by heat of fusion. In fact these changes in slope are nothing but points on either solidus or liquidus of a phase diagram. An experimental procedure where repeated cooling/heating of an alloy at different compositions, and corresponding changes in slope of cooling curves will be used to construct the phase diagram.

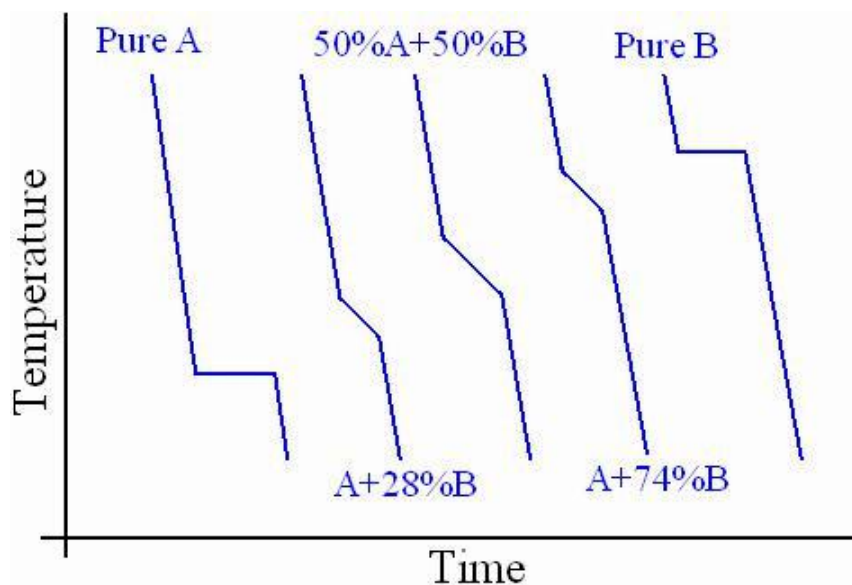

Figure-: Cooling curves for isomorphous binary system.

Another important aspect of interpreting phase diagrams along with phases present is finding the relative amount of phases present and their individual composition.

Procedure to find equilibrium concentrations of phases:

- A *tie-line* or *isotherm* (**UV**) is drawn across two-phase region to intersect the boundaries of the region.
- Perpendiculars are dropped from these intersections to the composition axis, represented by **U'** and **V'** in *figure-2*, from which each of each phase is read. **U'** represents composition of liquid phase and **V'** represents composition of solid phase as intersection **U** meets liquidus line and **V** meets solidus line.

Procedure to find equilibrium relative amounts of phases (*lever rule*):

- A tie-line is constructed across the two phase region at the temperature of the alloy to intersect the region boundaries.
- The relative amount of a phase is computed by taking the length of tie line from

overall composition to the phase boundary for the other phase, and dividing by the total tie-line length.

Eutectic system:

Many binary systems have components which have limited solid solubility, e.g.: Cu-Ag, Pb-Sn. The regions of limited solid solubility at each end of a phase diagram are called *terminal solid solutions* as they appear at ends of the diagram.

Many of the binary systems with limited solubility are of eutectic type, which consists of specific alloy composition known as *eutectic composition* that solidifies at a lower temperature than all other compositions. This low temperature which corresponds to the lowest temperature at which the liquid can exist when cooled under equilibrium conditions is known as *eutectic temperature*. The corresponding point on the phase diagram is called *eutectic point*. When the liquid of eutectic composition is cooled, at or below eutectic temperature this liquid transforms simultaneously into two solid phases (two terminal solid solutions, represented by α and β). This transformation is known as *eutectic reaction* and is written symbolically as:

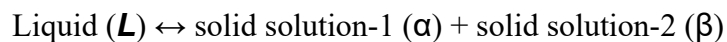

This eutectic reaction is called invariant reaction as it occurs under equilibrium conditions at a specific temperature and specific composition which can not be varied. Thus, this reaction is represented by a thermal horizontal arrest in the cooling curve of an alloy of eutectic composition. A typical eutectic type phase diagram is shown in *figure-4* along with a cooling curve.

As shown in *figure*, there exist three single phase regions, namely liquid (L), α and β phases. There also exist three two phase regions: $L+\alpha$, $L+\beta$ and $\alpha+\beta$. These three two phase regions are separated by horizontal line corresponding to the eutectic temperature. Below the eutectic temperature, the material is fully solid for all compositions. Compositions and relative amount of the phases can be determined using tie-lines and lever rule. Compositions that are on left-hand-side of the eutectic composition are known as *hypo-eutectic compositions* while compositions on right-hand-side of the eutectic composition are called *hyper-eutectic compositions*. Development of micro-structure and respective cooling curves for eutectic

alloys are shown in *figure-5, 6, 7 and 8* for different compositions. The phase that forms during cooling but before reaching eutectic temperature is called *pro-eutectic phase*.

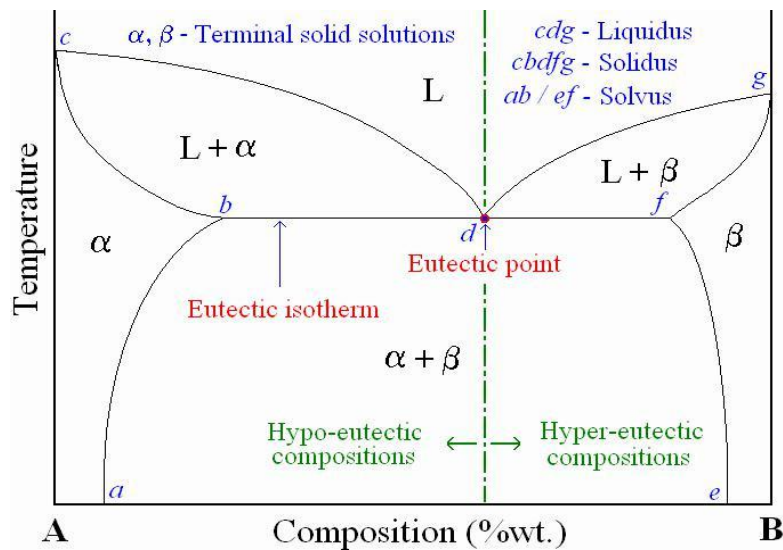

Figure: Typical phase diagram for a binary eutectic system.

In many systems, solidification in the solid + liquid region may lead to formation of layered (cored) grains, even at very slow cooling rates. This is as a result of very slow or no-diffusion in solid state compared with very high diffusion rates in liquids. The composition of the liquid phase evolves by diffusion, following the equilibrium values that can be derived from the tie-line method. However, new layers that solidify on top of the grains have the equilibrium composition at that temperature but once they are solid their composition does not change.

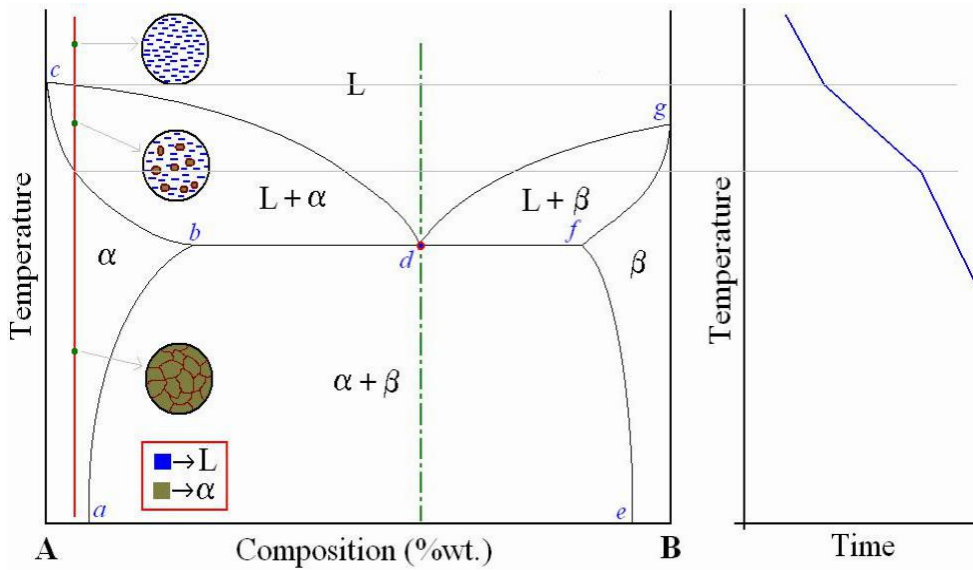

Figure: Cooling curve and micro-structure development for eutectic alloy that passes mainly through terminal solid solution.

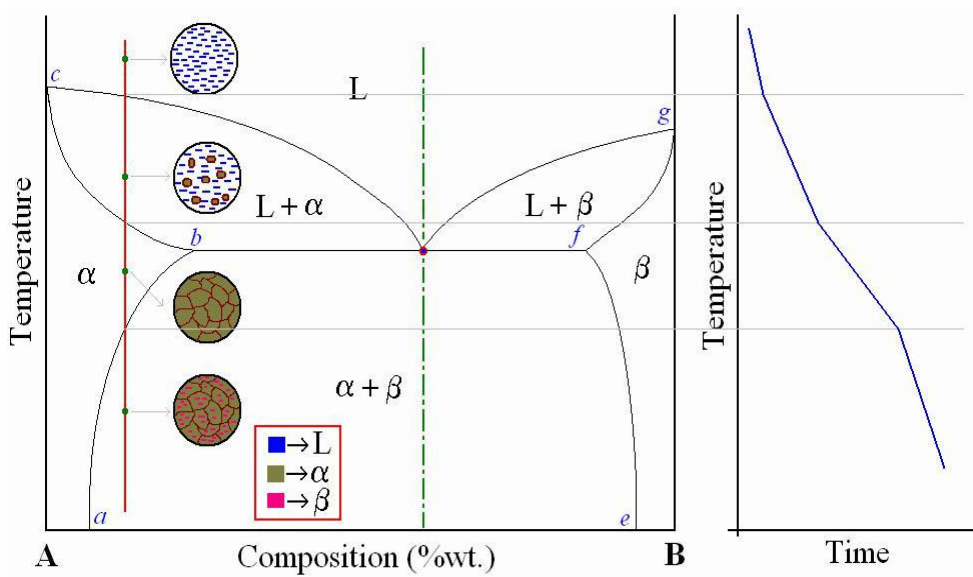

Figure: Cooling curve and micro-structure development for eutectic alloy that passes through terminal solid solution without formation of eutectic solid.

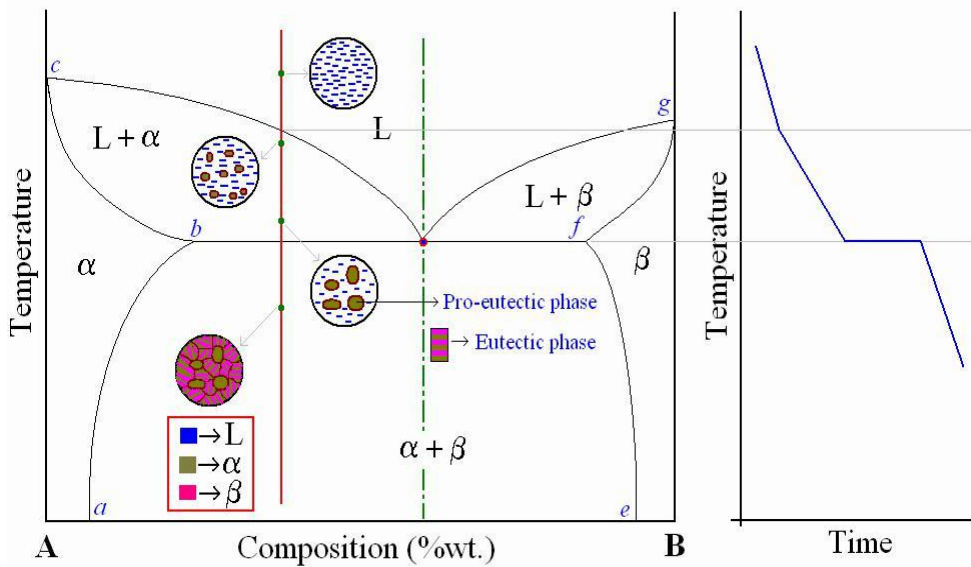

Figure: Cooling curve and micro-structure development for eutectic alloy that passes through hypo-eutectic region.

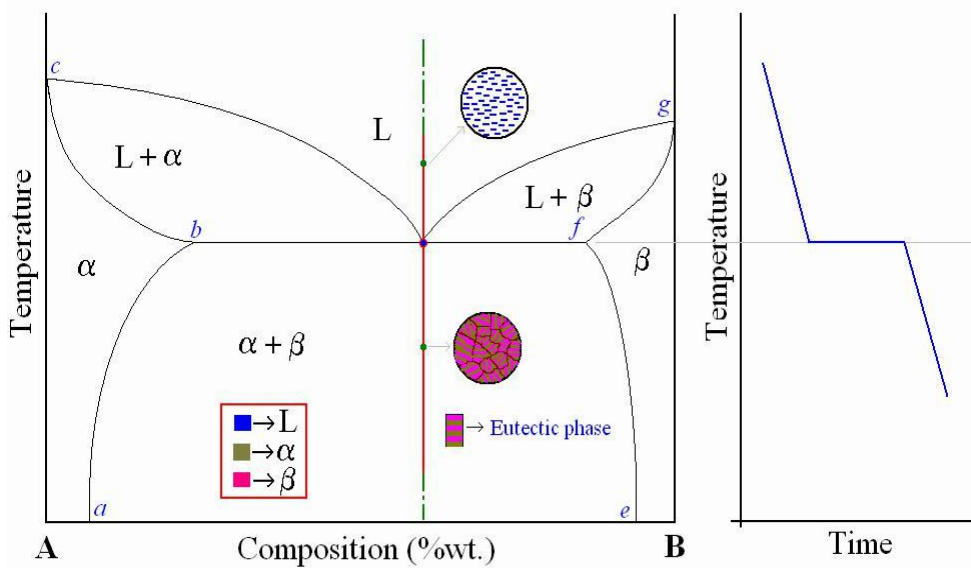

Figure: Cooling curve and micro-structure development for eutectic alloy that passes through eutectic-point.

Invariant reactions: The *eutectic reaction*, in which a liquid transforms into two solid phases, is just one of the possible three-phase invariant reactions that can occur in binary systems

those are not isomorphous. Schematically it can be shown as in *figure-*. It represents that a liquid phase, *L*, transforms into two different solids phases (α and β) upon cooling during the eutectic reaction.

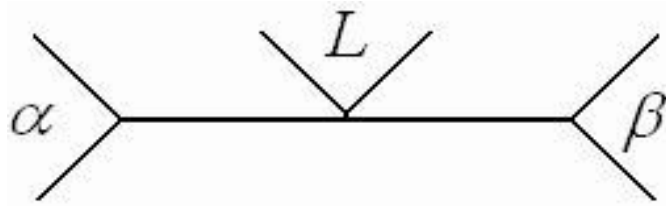
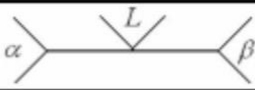



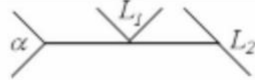
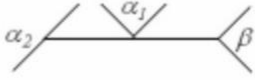
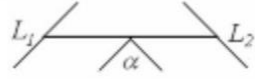

Figure-9: Schematic of eutectic invariant reaction.

In the solid state analog of a eutectic reaction, called a *eutectoid reaction*, one solid phase having eutectoid composition transforms into two different solid phases. Another set of invariant reactions that occur often in binary systems are - *peritectic reaction* where a solid phase reacts with a liquid phase to produce a new solid phase, and in *peritectoid reaction*, two solid phases react to form a new solid phase. Peritectic reaction is commonly present as part of more-complicated binary diagrams, particularly if the melting points of the two components are quite different. Peritectic and peritectoid reactions do not give rise to micro-constituents as the eutectic and eutectoid reactions do. Another invariant reaction that involves liquid phase is *monotectic reaction* in which a liquid phase transforms into a solid phase and a liquid phase of different composition. Over a certain range of compositions the two liquids are immiscible like oil and water and so constitute individual phases, thus monotectic reaction can said to be associated with miscibility gaps in the liquid state. Example system for monotectic reaction: Cu-Pb at 954 C and 36%Pb. Analog to monotectic reaction in solid state is *monotectoid reaction* in which a solid phase transforms to produce two solid phases of different compositions. Another notable invariant reaction that is associated with liquid immiscibility is *syntectic reaction* in which two liquid phases react to form a solid phase. All the invariant reactions are summarized in the *table-1* showing both symbolic reaction and schematic part of phase diagram.

Table-1: Summary of invariant reactions in binary systems

Reaction	Symbolic equation	Schematic presentation	Example
Eutectic	$L \leftrightarrow \alpha + \beta$		Fe-C, 4.27% C, 1147 °C
Eutectoid	$\alpha \leftrightarrow \beta + \gamma$		Fe-C, 0.80% C, 723 °C
Peritectic	$L + \alpha \leftrightarrow \beta$		Fe-C, 0.16% C, 1495 °C
Peritectoid	$\alpha + \beta \leftrightarrow \gamma$		
Monotectic	$L_1 \leftrightarrow L_2 + \alpha$		Fe-C, 0.51% C, 1495 °C
Monotectoid	$\alpha_1 \leftrightarrow \alpha_2 + \beta$		
Syntectic	$L_1 + L_2 \leftrightarrow \alpha$		

Intermediate phases:

An intermediate phase may occur over a composition range (intermediate solid solution) or at a relatively fixed composition (compound) inside the phase diagram and are separated from other two phases in a binary diagram by two phase regions. Many phase diagrams contain intermediate phases whose occurrence cannot be readily predicted from the nature of the pure components. Intermediate solid solutions often have higher electrical resistivities and hardnesses than either of the two components. Intermediate compounds form relatively at a fixed composition when there exists a stoichiometric relationship

between the components, for example: Mg_2Ni and $MgNi_2$ in Mg-Ni system. These are called *inter-metallic compounds*, and differ from other chemical compounds in that the bonding is primarily metallic rather than ionic or covalent, as would be found with compounds in certain metal-nonmetal or ceramic systems. Some metal-nonmetal

compounds, Fe_3C , are metallic in nature, whereas in others, MgO and Mg_2Si , bonding is mainly covalent. When using the lever rules, inter-metallic compounds are treated like any other phase, except they appear not as a wide region but as a vertical line.

Number of phase transformations may takes place for each system. Phase transformations in

which there are no compositional alternations are said to be *congruent transformations*, and during *incongruent transformations* at least one of the phases will experience a change in composition. Examples for (1) congruent transformations: allotropic transformations, and melting of pure materials (2) incongruent transformations: all invariant reactions, and also melting of alloy that belongs to an isomorphous system. Intermediate phases are sometimes classified on the basis of whether they melt congruently or incongruently. $MgNi_2$, for example, melts congruently whereas Mg_2Ni melts incongruently since it undergoes peritectic decomposition.

Particle strengthening by precipitation and precipitation reactions

As explained in an earlier chapter (*chapter-6: Dislocations and Strengthening Mechanisms*), by obstructing dislocation motion in different means, material's strength can be increased. One of the methods that are applicable to multi-phase material is particle strengthening in which second phase particles are introduced into the matrix by either mixing-and-consolidation (dispersion strengthening) or precipitated in solid state (precipitation hardening).

The object of the precipitation strengthening is to create in a heat-treated alloy a dense and fine dispersion of precipitated particles in a matrix of deformable metal. The particles act as obstacles to dislocation motion. In order for an alloy system to be able to precipitation-strengthened for certain alloy compositions; there must be a terminal solid solution which has a decreasing solid solubility as the temperature decreases.

Precipitation strengthening and reactions that occur during precipitation can be best illustrated using the Al-4%Cu (duralumin) system. *Figure-10* depicts the Al-rich end of the Al-Cu phase diagram. It can be observed that the alloy with 4%Cu exists as a single phase α -solid solution at around 550 C, and at room temperature as a mixture of α (with less than 0.5%Cu) and an inter-metallic compound, $CuAl_2$ (θ) with 52%Cu. On slow cooling α rejects excess Cu as precipitate particles of θ . These particles relatively coarse in size and can cause only moderate strengthening effect.

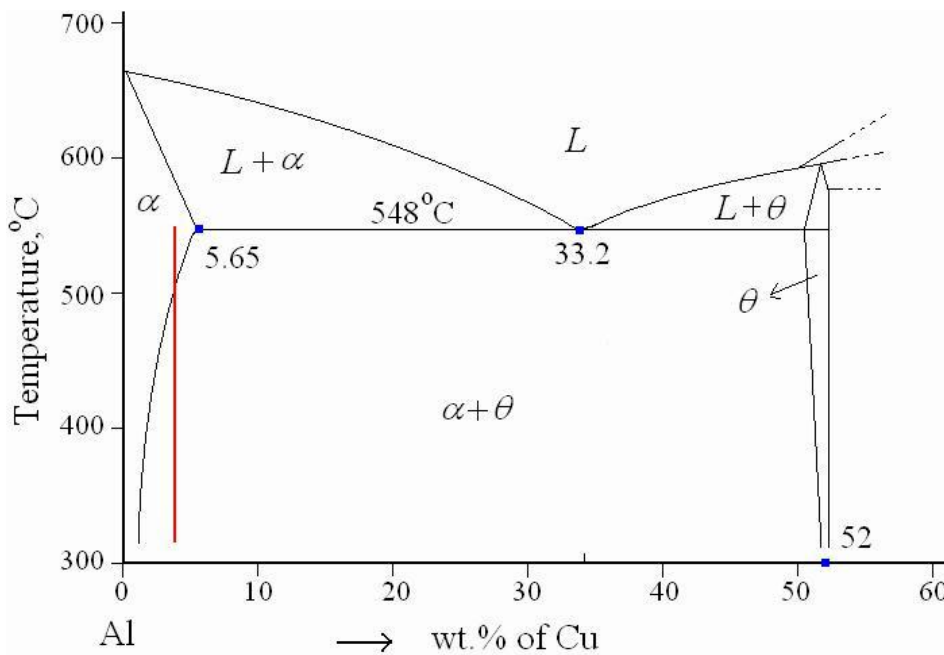

Figure Aluminium rich end of Al-Cu phase diagram.

By rapidly cooling the alloy, a supersaturated solution can be obtained at room temperature.

As a function of time at room temperature, and at higher temperatures up to

200 °C, the diffusion of Cu atoms may take place and the precipitate particles can form.

For this particular alloy, Al-4%Cu, five sequential structures can be identified: (a)

supersaturated solid solution α , (b) GP1 zones, (c) GP2 zones (θ'' phase), (d) θ' phase and

(e) θ phase, CuAl_2 . Not all these phases can be produced at all aging temperatures. GP1

and GP2 zones are produced at lower temperatures, and θ' and θ phases occur at higher

temperatures. The initial stages of precipitation are the most difficult to analyze because of

the extremely small size of the particles and their relatively uniform distribution. GP zones

meant for *Guinier-Preston* zones which have a definite composition and structure that is

not the same as that of the final stable precipitate. Evidently these particles are easier to

nucleate than the final precipitate, as a result, form first. Eventually they disappear as later

more stable phases appear. θ'' and θ' are meta- stable transition precipitates with distinct

crystal structure of their own, while θ is the equilibrium stable precipitate of CuAl_2 .

GP1 zones:-

These zones are created by Cu atoms segregating in α , and the segregated regions are of disk shape with thickness of 0.4-0.6 nm, and 8-10 nm in diameter and form on the {100} cubic

planes of the matrix. As Cu atoms which replace Al atoms are smaller in diameter, matrix lattice strains tetragonally. These zones are said to be coherent with the matrix lattice.

GP2 zones / θ'' phase:-

With additional aging, ordering of larger clumps of Cu atoms on $\{100\}$ occurs. These zones have tetragonal structure which therefore introduces coherency in the lattice with $\{100\}$ planes of the matrix, accompanied by further hardening. However, their size ranges from 1-4 nm thick and 10-100 nm in diameter as aging proceeds.

θ' phase:-

This phase nucleates heterogeneously especially on dislocations. It has tetragonal structure but is partially coherent with the matrix. This phase forms platelets with thickness 10-150 nm.

θ phase:-

With still further aging the equilibrium phase CuAl_2 or θ is formed from the transition lattice θ' or directly from the matrix accompanied by a reduction in hardness. It has a BCT (body-centered-tetragonal) structure, and is incoherent with the matrix. As these particles are no longer coherent with the matrix, hardness is lower than at the stage when coherent was present. Over-aging continues with the growth of these particles controlled by diffusion. Variation of hardness with aging time is shown in *figure-11*.

The general sequence of precipitation in binary Al-Cu alloys can be represented as:

Supersaturated $\alpha \rightarrow$ GP1 zones \rightarrow GP2 zones (θ'' phase) \rightarrow θ' phase \rightarrow θ phase (CuAl_2)

Most precipitation-hardening systems operate in a similar way, peak hardness usually being attained in the later stages of coherency or at the onset of incoherency. It is quite common for a coherent precipitate to form and then lose coherency when the particle grows to a critical size. However, in some systems there is no evidence of coherency strains, and the fine particles θ appear to act alone as impediments to dislocation movements, for example – systems with dispersion strengthening.

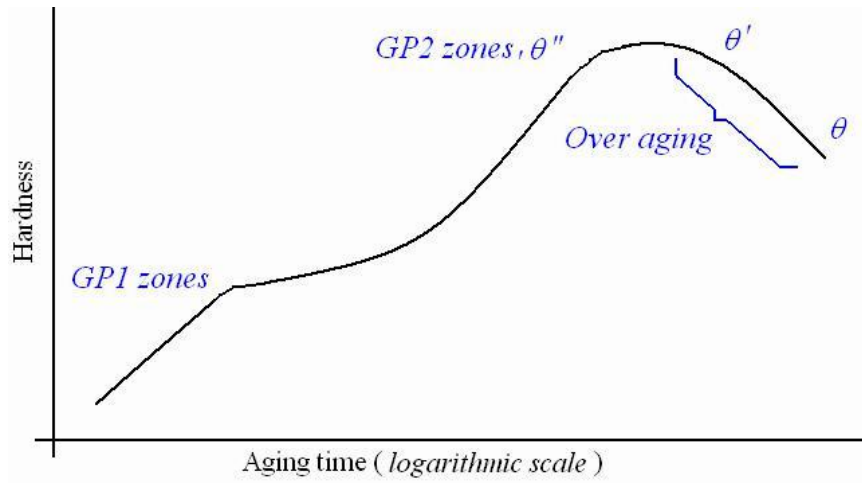

Figure Correlation of structures and hardness for Al-4%Cu alloy.

The iron – carbon system, phase transformations

A study of iron-carbon system is useful and important in many respects. This is because (1) steels constitute greatest amount of metallic materials used by man (2) solid state transformations that occur in steels are varied and interesting. These are similar to those occur in many other systems and helps explain the properties.

Iron-carbon phase diagram shown in *figure* is not a complete diagram. Part of the diagram after 6.67 wt% C is ignored as it has little commercial significance. The 6.67% C represents the composition where an inter-metallic compound, cementite (Fe_3C), with solubility limits forms. In addition, phase diagram is not true equilibrium diagram because cementite is not an equilibrium phase. However, in ordinary steels decomposition of cementite into graphite never observed because nucleation of cementite is much easier than that of graphite. Thus cementite can be treated as an equilibrium phase for practical purposes.

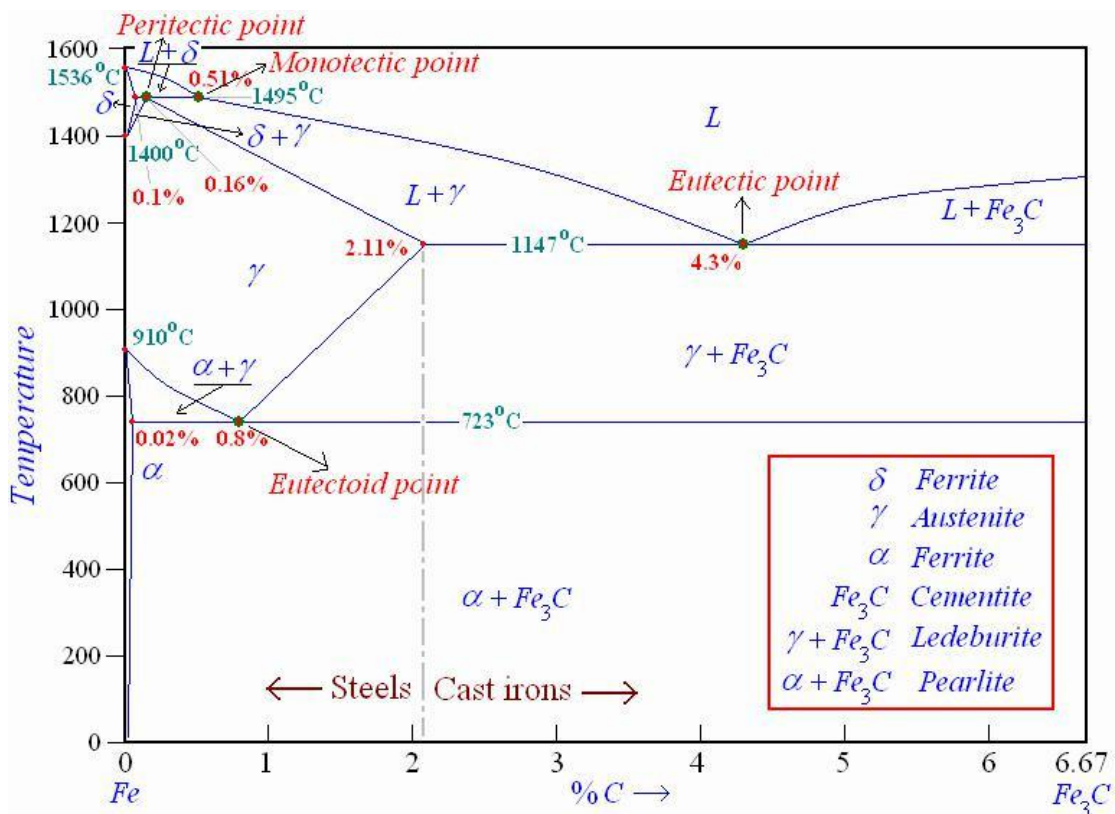

Figure- Iron – Iron carbide phase diagram.

The Fe-Fe₃C is characterized by five individual phases and four invariant reactions. Five phases that exist in the diagram are: α -ferrite (BCC) Fe-C solid solution, γ -austenite (FCC) Fe-C solid solution, δ -ferrite (BCC) Fe-C solid solution, Fe₃C (iron carbide) *or* cementite - an inter-metallic compound and liquid Fe-C solution. Four invariant reactions that cause transformations in the system are namely eutectoid, eutectic, monotectic and peritectic.

As depicted by left axes, pure iron upon heating exhibits two allotropic changes. One involves α -ferrite of BCC crystal structure transforming to FCC austenite, γ -iron, at 910 C.

At 1400 C, austenite changes to BCC phase known as δ -ferrite, which finally melts at 1536 C.

Carbon present in solid iron as interstitial impurity, and forms solid solution with ferrites / austenite as depicted by three single fields represented by α , γ and δ . Carbon dissolves least in α -ferrite in which maximum amount of carbon soluble is 0.02% at 723 C. This limited solubility is attributed to shape and size of interstitial position in BCC α -ferrite. However, carbon present greatly influences the mechanical properties of α -ferrite. α -ferrite can be used as magnetic material below 768 C. Solubility of carbon in γ -iron reaches its maximum, 2.11%, at a temperature of 1147 C. Higher solubility of carbon in austenite is attributed to FCC structure and corresponding interstitial sites. Phase transformations involving austenite plays very significant role in heat treatment of different steels. Austenite itself is non-magnetic. Carbon solubility in δ -ferrite is maximum (0.1%) at 1495 C. As this ferrite exists only at elevated temperatures, it is of no commercial importance. Cementite, Fe₃C an inter-metallic compound forms when amount of carbon present exceeds its solubility limit at respective temperatures. Out of these four solid phases, cementite is hardest and brittle that is used in different forms to increase the strength of steels. α -ferrite, on the other hand, is softest and act as matrix of a composite material. By combining these two phases in a solution, a material's properties can be varied over a large range.

For technological convenience, based on %C dissolved in it, a Fe-C solution is classified as: **commercial pure irons** with less than 0.008%C; **steels** having %C between 0.008-2.11; while **cast irons** have carbon in the range of 2.11%-6.67%. Thus commercial pure iron

is composed of exclusively α -ferrite at room temperature. Most of the steels and cast irons contain both α -ferrite and cementite. However, commercial cast irons are not simple alloys of iron and carbon as they contain large quantities of other elements such as silicon, thus better consider them as ternary alloys. The presence of Si promotes the formation of graphite instead of cementite. Thus cast irons may contain carbon in form of both graphite and cementite, while steels will have carbon only in combined form as cementite.

As shown in *figure*, and mentioned earlier, Fe-C system constitutes four invariant reactions:

- peritectic reaction at 1495 °C and 0.16% C, δ -ferrite + L \leftrightarrow γ -iron (austenite)
- monotectic reaction 1495 °C and 0.51% C, L \leftrightarrow L + γ -iron (austenite)
- eutectic reaction at 1147 °C and 4.3 %C, L \leftrightarrow γ -iron + Fe₃C (cementite) [ledeburite]
- eutectoid reaction at 723 °C and 0.8% C, γ -iron \leftrightarrow α -ferrite + Fe₃C (cementite) [pearlite]

Product phase of eutectic reaction is called ledeburite, while product from eutectoid reaction is called pearlite. During cooling to room temperature, ledeburite transforms into pearlite and cementite. At room temperature, thus after equilibrium cooling, Fe-C diagram consists of either α -ferrite, pearlite and/or cementite. Pearlite is actually not a single phase, but a micro-constituent having alternate thin layers of α -ferrite (~88%) and Fe₃C, cementite (~12%). Steels with less than 0.8% C (mild steels up to 0.3% C, medium carbon steels with C between 0.3%-0.8% i.e. hypo-eutectoid Fe-C alloys) i.e. consists pro-eutectoid α -ferrite in addition to pearlite, while steels with carbon higher than 0.8% (high-carbon steels i.e. hyper-eutectoid Fe-C alloys) consists of pearlite and pro-eutectoid cementite. Phase transformations involving austenite i.e. processes those involve eutectoid reaction are of great importance in heat treatment of steels.

In practice, steels are almost always cooled from the austenitic region to room temperature. During the cooling upon crossing the boundary of the single phase γ -iron, first pro-eutectoid phase (either α -ferrite or cementite) forms up to eutectoid temperature. With further cooling below the eutectoid temperature, remaining austenite decomposes to eutectoid product called pearlite, mixture of thin layers of α -ferrite and cementite. Though pearlite is not a phase, nevertheless, a constituent because it has a definite appearance under the

microscope and can be clearly identified in a structure composed of several constituents. The decomposition of austenite to form pearlite occurs by nucleation and growth. Nucleation, usually, occurs heterogeneously and rarely homogeneously at grain boundaries. When it is not homogeneous, nucleation of pearlite occurs both at grain boundaries and in the grains of austenite. When austenite forms pearlite at a constant temperature, the spacing between adjacent lamellae of cementite is very nearly constant. For a given colony of pearlite, all cementite plates have a common orientation in space, and it is also true for the ferrite plates. Growth of pearlite colonies occurs not only by the nucleation of additional lamellae but also through an advance at the ends of the lamellae. Pearlite growth also involves the nucleation of new colonies at the interfaces between established colonies and the parent austenite. The thickness ratio of the ferrite and cementite layers in pearlite is approximately 8 to 1. However, the absolute layer thickness depends on the temperature at which the isothermal transformation is allowed to occur.

The temperature at which austenite is transformed has a strong effect on the inter-lamellar spacing of pearlite. The lower the reaction temperature, the smaller will be inter-lamellar spacing. For example, pearlite spacing is in order of 10^{-3} mm when it formed at 700 C, while spacing is in order of 10^{-4} mm when formed at 600 C. The spacing of the pearlite lamellae has a practical significance because the hardness of the resulting structure depends upon it; the smaller the spacing, the harder the metal. The growth rate of pearlite is also a strong function of temperature. At temperatures just below the eutectoid, the growth rate increases rapidly with decreasing temperature, reaching a maximum at 600 C, and then decreases again at lower temperatures.

Additions of alloying elements to Fe-C system bring changes (alternations to positions of phase boundaries and shapes of fields) depends on that particular element and its concentration. Almost all alloying elements causes the eutectoid concentration to decrease, and most of the alloying elements (e.g.: Ti, Mo, Si, W, Cr) causes the eutectoid temperature to increase while some other (e.g.: Ni, Mn) reduces the eutectoid temperature. Thus alloying additions alters the relative amount of pearlite and pro- eutectoid phase that form.

Fe-C alloys with more than 2.11% C are called cast irons. Phase transformations in cast irons involve formation of pro-eutectic phase on crossing the liquidus. During the further cooling, liquid of eutectic composition decomposes into mixture of austenite and cementite, known as ledeburite. On further cooling through eutectoid temperature, austenite decomposes to pearlite. The room temperature microstructure of cast irons thus consists of pearlite and cementite. Because of presence of cementite, which is hard, brittle and white in color, product is called *white cast iron*. However, depending on cooling rate and other alloying elements, carbon in cast iron may be present as graphite or cementite. *Gray cast iron* contains graphite in form of flakes. These flakes are sharp and act as stress risers. Brittleness arising because of flake shape can be avoided by producing graphite in spherical nodules, as in *malleable cast iron* and *SG (spheroidal graphite) cast iron*. Malleable cast iron is produced by heat treating white cast iron (Si < 1%) for prolonged periods at about 900 C and then cooling it very slowly. The cementite decomposes and temper carbon appears approximately as spherical particles. SG iron is produced by adding inoculants to molten iron. In these Si content must be about 2.5%, and no subsequent heat treatment is required.

Transformation rate effects and TTT diagrams, Microstructure and Property Changes in Fe-C Alloys

Solid state transformations, which are very important in steels, are known to be dependent on time at a particular temperature, as shown in *figure-14(b)*. Isothermal transformation diagram, also known as TTT diagram, measures the rate of transformation at a constant temperature i.e. it shows time relationships for the phases during isothermal transformation. Information regarding the time to start the transformation and the time required to complete the transformation can be obtained from set of TTT diagrams. One such set of diagram for reaction of austenite to pearlite in steel is shown in *figure-17*. The diagram is not complete in the sense that the transformations of austenite that occur at temperatures below about 550 C are not shown.

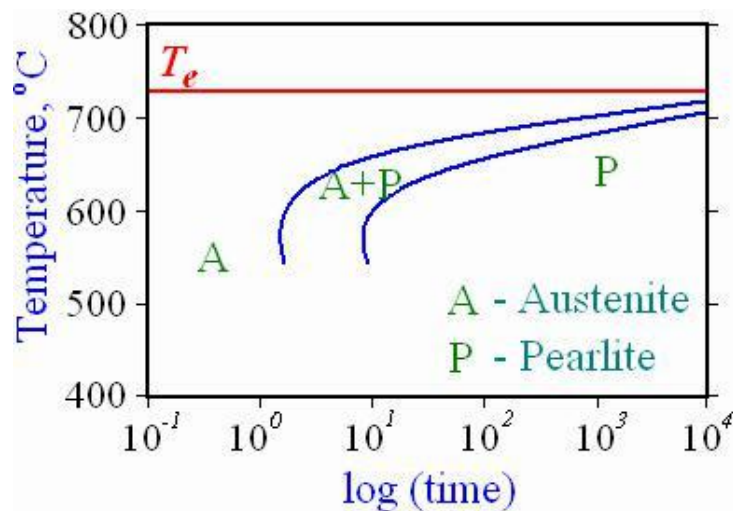

Figure- Partial TTT diagram for a eutectoid Fe-C alloy.

As mentioned in previous section, thickness of layers in pearlite depends on the temperature at which the transformation occurred. If the transformation took place at a temperature that is just below the eutectoid temperature, relatively thick layers of α - ferrite and cementite are produced in what is called *coarse pearlite*. This is because of high diffusion rates of carbon atoms. Thus with decreasing transformation temperature, sluggish movement of carbon results in thinner layers α -ferrite and cementite i.e. *fine pearlite* is produced.

At transformation temperatures below 550 C, austenite results in different product known as bainite. Bainite also consists of α -ferrite and cementite phases i.e. transformation is again diffusion controlled but morphologically it consists of very small particles of cementite within or between fine ferrite plates. Bainite forms needles or plates, depending on the temperature of the transformation; the microstructural details of bainite are so fine that their resolution is only possible using electron microscope. It differs from pearlite in the sense that different mechanism is involved in formation of bainite which does not have alternating layers of α -ferrite and cementite. In addition, because of equal growth rates in all directions pearlite tends to form spherical colonies, whereas bainite grows as plates and has a characteristic acicular (needlelike) appearance. *Upper bainite*, formed at the upper end of the temperature range (550 C-350 C), is characterized by relatively coarse, irregular shaped cementite particles in α -ferrite plates. If the transformation is taking place at lower temperatures (350 C-250 C), the α -ferrite plates assume a more regular needlelike shape, and the transformation product is called *lower bainite*. At the same time carbide particles become smaller in size and appear as cross-striations making an angle of about 55° to the axis of the α -ferrite plate. Upper bainite has large rod-like cementite regions, whereas lower bainite has much finer cementite particles as a result of sluggish diffusion of carbon atoms at lower temperatures. Lower bainite is considerably harder than upper bainite. Another characteristic of bainite is that as it has crystallographic orientation that is similar to that found in simple ferrite nucleating from austenite, it is believed that bainite is nucleated by the formation of ferrite. This is in contrast to pearlite which is believed to be nucleated by formation of cementite.

Basically, bainite is a transformation product that is not as close to equilibrium as pearlite. The most puzzling feature of the bainite reaction is its dual nature. In a number of respects, it reveals properties that are typical of a nucleation and growth type of transformation such as occurs in the formation of pearlite and also a mixture of α -ferrite and cementite though of quite different morphology (no alternate layers), but at the same time it differs from the Martensite as bainite formation is athermal and diffusion controlled though its microstructure is characterized by acicular (needlelike) appearance.

The time-temperature dependence of the bainite transformation can also be presented using TTT diagram. It occurs at temperatures below those at which pearlite forms i.e. it does not form until the transformation temperature falls below a definite temperature, designated as B_S . Above this temperature austenite does not form bainite except under external stresses. Below B_S , austenite does not transform completely to bainite. The amount of bainite formed increases as the isothermal reaction temperature is lowered. By reaching a lower limiting temperature, B_f , it is possible to transform austenite completely to bainite. The B_S and B_f temperatures are equivalent to the M_S and M_f temperatures for Martensite.

In simple eutectoid steels, pearlite and bainite transformations overlap, thus transition from the pearlite to bainite is smooth and continuous i.e. knees of individual pearlite and bainite curves are merged together. However each of the transformations has a characteristic C-curve, which can be distinguishable in presence of alloying elements. As shown in complete TTT diagram for eutectoid steel in *figure-18*, above approximately

550 C-600 C, austenite transforms completely to pearlite. Below this range up to 450

C, both pearlite and bainite are formed. Finally, between 450 C and 210 C, the reaction product is bainite only. Thus bainite transformation is favored at a high degree of supercooling, and the pearlite transformation at a low degree of supercooling. In middle region, pearlitic and bainitic transformations are competitive with each other.

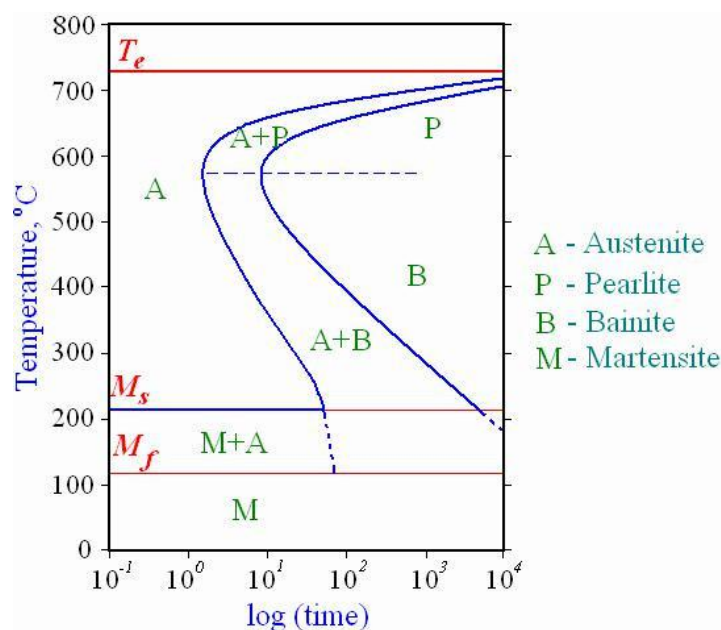

Figure- Complete TTT (isothermal transformation) diagram for eutectoid steel.

As explained in earlier section, martensitic transformation can dominate the proceedings if steel is cooled rapid enough so that diffusion of carbon can be arrested. Transformation of austenite to Martensite is diffusion-less, time independent and the extent of transformation depends on the transformation temperature. Martensite is a *meta-stable* phase and decomposes into ferrite and pearlite but this is extremely slow (and not noticeable) at room temperature. Alloying additions retard the formation rate of pearlite and bainite, thus rendering the martensitic transformation more competitive. Start of the transformation is designated by M_S , while the completion is designated by M_f in a transformation diagram. Martensite forms in steels possesses a body centered tetragonal crystal structure with carbon atoms occupying one of the three interstitial sites available. This is the reason for characteristic structure of steel Martensite instead of general BCC. Tetragonal distortion caused by carbon atoms increases with increasing carbon content and so is the hardness of Martensite. Austenite is slightly denser than Martensite, and therefore, during the phase transformation upon quenching, there is a net volume increase. If relatively large pieces are rapidly quenched, they may crack as a result of internal stresses, especially when carbon content is more than about 0.5%.

Mechanically, Martensite is extremely hard, thus its applicability is limited by brittleness associated with it. Characteristics of steel Martensite render it unusable for structural applications in the as-quenched form. However, structure and thus the properties can be altered by *tempering*, heat treatment observed below eutectoid temperature to permit diffusion of carbon atoms for a reasonable period of time. During tempering, carbide particles attain spherical shape and are distributed in ferrite phase – structure called *spheroidite*. Spheroidite is the softest yet toughest structure that steel may have. At lower tempering temperature, a structure called *tempered Martensite* forms with similar microstructure as that of spheroidite except that cementite particles are much, much smaller. The tempering heat treatment is also applicable to pearlitic and bainitic structures. This mainly results in improved machinability. The mechanism of tempering appears to be first the precipitation of fine particles of hexagonal ϵ -carbide of composition about $Fe_{2.4}C$ from Martensite, decreasing its tetragonality. At higher temperatures or with increasing tempering times, precipitation of cementite begins and is accompanied by dissolution of the unstable ϵ -carbide. Eventually the Martensite loses its tetragonality and becomes BCC

ferrite, the cementite coalesces into spheres. A schematic of possible transformations involving austenite decomposition are shown in *figure-19*.

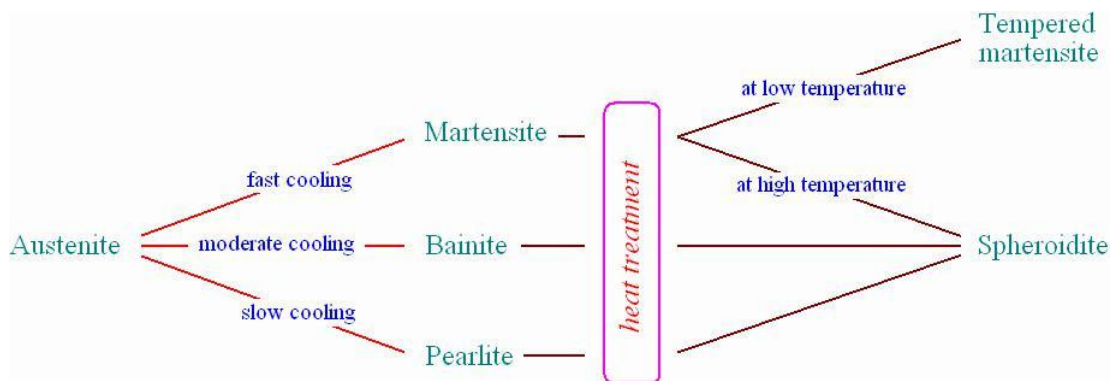

Figure-: Possible transformation involving austenite decomposition.

Tempering of some steels may result in a reduction of toughness what is known as *temper embrittlement*. This may be avoided by (1) compositional control, and/or (2) tempering above 575 or below 375, followed by quenching to room temperature. The effect is greatest in Martensite structures, less severe in bainitic structures and least severe in pearlite structures. It appears to be associated with the segregation of solute atoms to the grain boundaries lowering the boundary strength. Impurities responsible for temper brittleness are: P, Sn, Sb and As. Si reduces the risk of embrittlement by carbide formation. Mo has a stabilizing effect on carbides and is also used to minimize the risk of temper brittleness in low alloy steels.

TTT diagrams are less of practical importance since an alloy has to be cooled rapidly and then kept at a temperature to allow for respective transformation to take place. However, most industrial heat treatments involve continuous cooling of a specimen to room temperature. Hence, Continuous Cooling Transformation (CCT) diagrams are generally more appropriate for engineering applications as components are cooled (air cooled, furnace cooled, quenched etc.) from a processing temperature as this is more economic than transferring to a separate furnace for an isothermal treatment. CCT diagrams measure the extent of transformation as a function of time for a continuously decreasing temperature. For continuous cooling, the time required for a reaction to begin and end is delayed, thus the isothermal curves are shifted to longer times and lower temperatures.

Both TTT and CCT diagrams are, in a sense, phase diagrams with added parameter in form of time. Each is experimentally determined for an alloy of specified composition. These diagrams allow prediction of the microstructure after some time period for constant temperature and continuous cooling heat treatments, respectively. Normally, bainite will not form during continuous cooling because all the austenite will have transformed to pearlite by the time the bainite transformation has become possible. Thus, as shown in *figure-20*, region representing austenite-pearlite transformation terminates just below the nose.

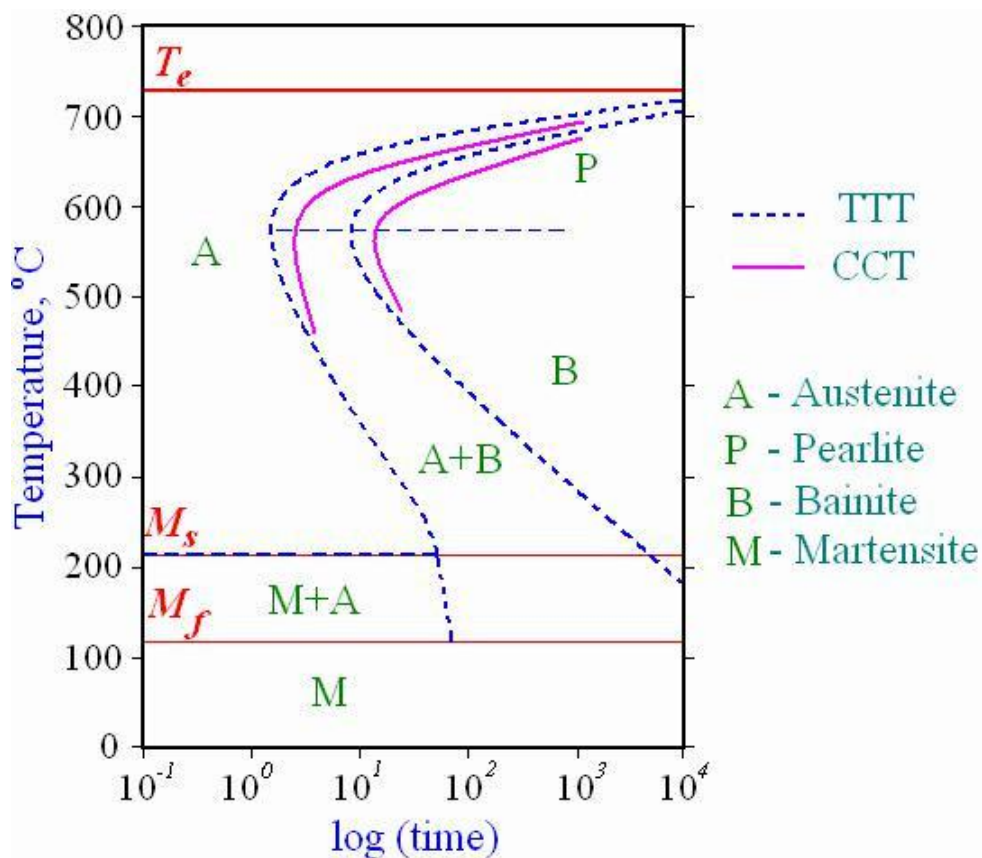

Figure- Superimposition of TTT and CCT diagrams for a eutectoid steel.

Applications and Processing of Metals and Alloys

In the materials world we are living in, when making a new device/component, most often we come across a very familiar problem. This is nothing but select the right material. As learnt in earlier chapter, selection of material can play very important role preventing failures. Selection of material for a specific purpose depends on many factors. Some of the important ones are: strength, ease of forming, resistance to environmental degradation, etc. Another dimension an engineer should be aware of it is how to tailor the required properties of materials.

As introduced in one of the earlier chapters, materials can be broadly classified as metals, ceramics and plastics. This chapter introduces different classes of metallic materials, common fabrication methods, and means to alter their properties on purpose. Following chapters deal with ceramic materials and plastic materials.

Types of metals and alloys

Metallic materials are broadly of two kinds – *ferrous* and *non-ferrous* materials. This classification is primarily based on tonnage of materials used all around the world. Ferrous materials are those in which iron (**Fe**) is the principle constituent. All other materials are categorized as non-ferrous materials. Another classification is made based on their formability. If materials are hard to form, components with these materials are fabricated by casting, thus they are called cast alloys. If material can be deformed, they are known as wrought alloys. Materials are usually strengthened by two methods – cold work and heat treatment. Strengthening by heat treatment involves either precipitation hardening or martensitic transformation, both of which constitute specific heat treating procedure. When a material can not be strengthened by heat treatment, it is referred as non-heat-treatable alloys.

Ferrous materials

Ferrous materials are produced in larger quantities than any other metallic material. Three factors account for it: (a) availability of abundant raw materials combined with economical extraction, (b) ease of forming and (c) their versatile mechanical and physical properties. One main drawback of ferrous alloys is their environmental degradation i.e. poor corrosion resistance. Other disadvantages include: relatively high density and comparatively low electrical and thermal conductivities. In ferrous materials the main alloying element is carbon (**C**). Depending on the amount of carbon present, these alloys will have different properties, especially when the carbon content is either less/higher than 2.14%. This amount of carbon is specific as below this amount of carbon, material undergoes eutectoid transformation, while above that limit ferrous materials undergo eutectic transformation. Thus the ferrous alloys with less than 2.14% C are termed as **steels**, and the ferrous alloys with higher than 2.14% C are termed as **cast irons**.

Steels

Steels are alloys of iron and carbon plus other alloying elements. In steels, carbon present in atomic form, and occupies interstitial sites of Fe microstructure. Alloying additions are necessary for many reasons including: improving properties, improving corrosion resistance, etc. Arguably steels are well known and most used materials than any other materials.

Mechanical properties of steels are very sensitive to carbon content. Hence, it is practical to classify steels based on their carbon content. Thus steels are basically three kinds: low-carbon steels (% wt of C < 0.3), medium carbon steels (0.3 < % wt of C < 0.6) and high-carbon steels (% wt of C > 0.6). The other parameter available for classification of steels is amount of alloying additions, and based on this steels are two kinds: (plain) carbon steels and alloy-steels.

Low carbon steels:

These are arguably produced in the greatest quantities than other alloys. Carbon present in these alloys is limited, and is not enough to strengthen these materials by heat treatment;

hence these alloys are strengthened by cold work. Their microstructure consists of ferrite and pearlite, and these alloys are thus relatively soft, ductile combined with high toughness. Hence these materials are easily machinable and weldable. Typical applications of these alloys include: structural shapes, tin cans, automobile body components, buildings, etc.

A special group of ferrous alloys with noticeable amount of alloying additions are known as HSLA (high-strength low-alloy) steels. Common alloying elements are: Cu, V, Ni, W, Cr, Mo, etc. These alloys can be strengthened by heat treatment, and yet the same time they are ductile, formable. Typical applications of these HSLA steels include: support columns, bridges, pressure vessels.

Medium carbon steels:

These are stronger than low carbon steels. However these are of less ductile than low carbon steels. These alloys can be heat treated to improve their strength. Usual heat treatment cycle consists of austenitizing, quenching, and tempering at suitable conditions to acquire required hardness. They are often used in tempered condition. As hardenability of these alloys is low, only thin sections can be heat treated using very high quench rates. Ni, Cr and Mo alloying additions improve their hardenability. Typical applications include: railway tracks & wheels, gears, other machine parts which may require good combination of strength and toughness.

High carbon steels:

These are strongest and hardest of carbon steels, and of course their ductility is very limited. These are heat treatable, and mostly used in hardened and tempered conditions. They possess very high wear resistance, and capable of holding sharp edges. Thus these are used for tool application such as knives, razors, hacksaw blades, etc. With addition of alloying element like Cr, V, Mo, W which forms hard carbides by reacting with carbon present, wear resistance of high carbon steels can be improved considerably.

Stainless steels:

The name comes from their high resistance to corrosion i.e. they are rust- less (stain-less). Steels are made highly corrosion resistant by addition of special alloying elements, especially a minimum of 12% Cr along with Ni and Mo. Stainless steels are mainly three kinds: ferritic & hardenable Cr steels, austenitic and precipitation hardenable (martensitic, semi-austenitic) steels. This classification is based on prominent constituent of the microstructure. Typical applications include cutlery, razor blades, surgical knives, etc.

Ferritic stainless steels are principally Fe-Cr-C alloys with 12-14% Cr. They also contain small additions of Mo, V, Nb, and Ni.

Austenitic stainless steels usually contain 18% Cr and 8% Ni in addition to other minor alloying elements. Ni stabilizes the austenitic phase assisted by C and N. Other alloying additions include Ti, Nb, Mo (prevent weld decay), Mn and Cu (helps in stabilizing austenite).

By alloying additions, for martensitic steels ***M_s*** is made to be above the room temperature. These alloys are heat treatable. Major alloying elements are: Cr, Mn and Mo.

Ferritic and austenitic steels are hardened and strengthened by cold work because they are not heat treatable. On the other hand martensitic steels are heat treatable. Austenitic steels are most corrosion resistant, and they are produced in large quantities. Austenitic steels are non-magnetic as against ferritic and martensitic steels, which are magnetic.

Cast irons

Though ferrous alloys with more than 2.14 wt.% C are designated as cast irons, commercially cast irons contain about 3.0-4.5% C along with some alloying additions.

Alloys with this carbon content melt at lower temperatures than steels i.e. they are responsive to casting. Hence casting is the most used fabrication technique for these alloys.

Hard and brittle constituent presented in these alloys, cementite is a meta-stable phase, and can readily decompose to form α -ferrite and graphite. In this way disadvantages of brittle phase can easily be overcome. Tendency of cast irons to form graphite is usually controlled by their composition and cooling rate. Based on the form of carbon present, cast irons are categorized as gray, white, nodular and malleable cast irons.

Gray cast iron:

These alloys consist of carbon in the form of graphite flakes, which are surrounded by either ferrite or pearlite. Because of the presence of graphite, the fractured surface of these alloys looks grayish, and so is the name for them. Alloying addition of Si (1- 3wt.%) is responsible for the decomposition of cementite, and also high fluidity. Thus castings of intricate shapes can be easily made. Due to graphite flakes, gray cast irons are weak and brittle. However, they possess good damping properties, and thus typical applications include: base structures, bed for heavy machines, etc. They also show high resistance to wear.

White cast iron:

When Si content is low (< 1%) in combination with faster cooling rates, there is no time left for cementite to get decomposed, thus most of the brittle cementite remains. Because of the presence of cementite, the fractured surface appears white, hence the name. They are very brittle and extremely difficult to machine. Hence their use is limited to wear-resistant applications such as rollers in rolling mills. Usually white cast iron is heat treated to produce malleable iron.

Nodular (or ductile) cast iron:

Alloying additions are of prime importance in producing these materials. Small additions of Mg / Ce to the gray cast iron melt before casting can result in graphite to form nodules

or sphere-like particles. Matrix surrounding these particles can be either ferrite or pearlite depending on the heat treatment. These are stronger and ductile than gray cast irons. Typical applications include: pump bodies, crank shafts, automotive components, etc.

Malleable cast iron:

These formed after heat treating white cast iron. Heat treatments involve heating the material up to 800-900 C, and keep it for long hours, before cooling it to room temperature. High temperature incubation causes cementite to decompose and form ferrite and graphite. Thus these materials are stronger with appreciable amount of ductility. Typical applications include: railroad, connecting rods, marine and other heavy- duty services.

Non-ferrous materials

Non-ferrous materials have specific advantages over ferrous materials. They can be fabricated with ease, high relatively low density, and high electrical and thermal conductivities. However different materials have distinct characteristics, and are used for specific purposes. This section introduces some typical non-ferrous metals and their alloys of commercial importance.

Aluminium alloys:

These are characterized by low density, high thermal & electrical conductivities, and good corrosion resistant characteristics. As Al has FCC crystal structure, these alloys are ductile even at low temperatures and can be formed easily. However, the great limitation of these alloys is their low melting point (660 C), which restricts their use at elevated temperatures. Strength of these alloys can be increased by both cold and heat treatment – based on these alloys are designated in to two groups, cast and wrought. Chief alloying elements include: Cu, Si, Mn, Mg, Zn. Recently, alloys of Al and other low-density metals like Li, Mg, Ti gained much attention as there is much concern about vehicle weight reduction. Al-Li alloys enjoy much more attention especially as they are very useful in

aircraft and aerospace industries. Common applications of Al alloys include: beverage cans, automotive parts, bus bodies, aircraft structures, etc. Some of the Al alloys are capable of strengthening by precipitation, while others have to be strengthened by cold work or solid solution methods.

Copper alloys:

As history goes by, bronze has been used for thousands of years. It is actually an alloy of Cu and Sn. Unalloyed Cu is soft, ductile thus hard to machine, and has virtually unlimited capacity for cold work. One special feature of most of these alloys is their corrosion resistant in diverse atmospheres. Most of these alloys are strengthened by either cold work or solid solution method. Common most Cu alloys: Brass, alloys of Cu and Zn where Zn is substitutional addition (e.g.: yellow brass, cartridge brass, muntz metal, gilding metal); Bronze, alloys of Cu and other alloying additions like Sn, Al, Si and Ni. Bronzes are stronger and more corrosion resistant than brasses. Mention has to be made about Beryllium coppers who possess combination of relatively high strength, excellent electrical and corrosion properties, wear resistance, can be cast, hot worked and cold worked. Applications of Cu alloys include: costume jewelry, coins, musical instruments, electronics, springs, bushes, surgical and dental instruments, radiators, etc.

Magnesium alloys:

The most sticking property of Mg is its low density among all structural metals. Mg has HCP structure, thus Mg alloys are difficult to form at room temperatures. Hence Mg alloys are usually fabricated by casting or hot working. As in case of Al, alloys are cast or wrought type, and some of them are heat treatable. Major alloying additions are: Al, Zn, Mn and rare earths. Common applications of Mg alloys include: hand-held devices like saws, tools, automotive parts like steering wheels, seat frames, electronics like casing for laptops, camcoders, cell phones etc.

Titanium alloys:

Ti and its alloys are of relatively low density, high strength and have very high melting point. At the same time they are easy to machine and forge. However the major limitation

is Ti's chemical reactivity at high temperatures, which necessitated special techniques to extract. Thus these alloys are expensive. They also possess excellent corrosion resistance in diverse atmospheres, and wear properties. Common applications include: space vehicles, airplane structures, surgical implants, and petroleum & chemical industries.

Refractory metals:

These are metals of very high melting points. For example: Nb, Mo, W and Ta. They also possess high strength and high elastic modulus. Common applications include: space vehicles, x-ray tubes, welding electrodes, and where there is a need for corrosion resistance.

Noble metals:

These are eight all together: Ag, Au, Pt, Pa, Rh, Ru, Ir and Os. All these possess some common properties such as: expensive, soft and ductile, oxidation resistant.

Ag, Au and Pt are used extensively in jewelry, alloys are Ag and Au are employed as dental restoration materials; Pt is used in chemical reactions as a catalyst and in thermo couples.

Thermal processing of metals and alloys

Apart from mechanical processing, metals are very often subjected to thermal processing for various reasons, like: to refine grain structure/size, to minimize residual stresses, to impart phase changes, to develop special phases over external surfaces, etc. Metals and alloys develop requisite properties by thermal processing either through grain refinement or phase changes. Thermal processing is also known as heat treatment. Heat treatment originated as an ancient art in man's attempts to improve the performance of materials in their practical applications. In present day metallurgical practice, heat treatment has become very important for obvious reasons. There has been tremendous progress over centuries in the systematic understanding of materials structure and structure-property relationships that eliminated the empiricism in thermal processing. Properly designed and implemented thermal processing can result in optimum modifications in the composition and distribution of phases, corresponding changes in physical, chemical and mechanical properties at substantial levels. However, most of the thermal processes are aimed to improving mechanical characteristics of materials. Thus it is possible to extend the service performance of materials considerably within constraints of available resources.

All metals can be subjected to thermal processing. But the effect of it may differ from one metal to another. Metals are subjected to heat treatment for one or more of the following purposes: improvement in ductility; relieving internal stresses; grain size refinement; increase of strength; improvement in machinability, toughness; etc.

Heat treatment of materials involves number of factors – temperature up to which material is heated, length of time that the material is held at the elevated temperature, rate of cooling, and the surrounding atmosphere under the thermal treatment. All these factors depend on material, pre-processing of the material's chemical composition, size and shape of the object, final properties desired, material's melting point/liquidus, etc.

Thermal processes may be broadly classified into two categories based on cooling rates from elevated temperatures – annealing and quenching & tempering. Annealing involved cooling the material from elevated temperatures slowly, while quenching means very fast cooling of the material using cooling medium like water/oil bath. Quenching is done to retain the phases of elevated temperatures at room temperature.

Annealing processes

The term annealing was used by craftsmen who discovered the beneficial effects of heating the material at elevated temperatures followed by slow cooling of it to room temperature. *Annealing* can be defined as a heat treatment process in which the material is taken to a high temperature, kept there for some time and then cooled. High temperatures allow diffusion processes to occur fast. The time at the high temperature (soaking time) must be long enough to allow the desired transformation to occur. Cooling is done slowly to avoid the distortion (warping) of the metal piece, or even cracking, caused by stresses induced by differential contraction due to thermal inhomogeneities. Benefits of annealing are:

- relieve stresses
- increase softness, ductility and toughness
- produce a specific microstructure

Depending on the specific purpose, annealing is classified into various types: process annealing, stress relief, full annealing and normalizing.

Process annealing is primarily applied to cold worked metals to negate the effects of cold work. During this heat treatment, material becomes soft and thus its ductility will be increased considerably. It is commonly sandwiched between two cold work operations. During this, recovery and recrystallization are allowed whereas grain growth was restricted.

Stress relief operation removes the stresses that might have been generated during plastic deformation, non-uniform cooling, or phase transformation. Unless removed, these stresses

may cause distortion of components. Temperature used is normally low such that effects resulting from cold working are not affected.

Full annealing is normally used for products that are to be machined subsequently, such as transmission gear blanks. After heating and keeping at an elevated temperature, components are cooled in furnace to effect very slow cooling rates. Typically, the product receives additional heat treatments after machining to restore hardness and strength.

Normalizing is used to refine the grains and produce a more uniform and desirable size distribution. It involves heating the component to attain single phase (e.g.: austenite in steels), then cooling in open air atmosphere.

Quenching and Tempering processes

Quenching is heat treatment process where material is cooled at a rapid rate from elevated temperature to produce Martensite phase. This process is also known as *hardening*. Rapid cooling rates are accomplished by immersing the components in a quench bath that usually contains quench media in form of either water or oil, accompanied by stirring mechanism.

Quenching process is almost always followed by tempering heat treatment. *Tempering* is the process of heating martensitic steel at a temperature below the eutectoid transformation temperature to make it softer and more ductile. During the tempering process, Martensite transforms to a structure containing iron carbide particles in a matrix of ferrite.

Martempering is a modified quenching procedure used to minimize distortion and cracking that may develop during uneven cooling of the heat-treated material. It involves cooling the austenized steel to temperature just above M_s temperature, holding it there until temperature is uniform, followed by cooling at a moderate rate to room temperature before

austenite-to-bainite transformation begins. The final structure of martempered steel is tempered Martensite.

Austempering is different from martempering in the sense that it involves austenite-to-bainite transformation. Thus, the structure of austempered steel is bainite. Advantages of austempering are – improved ductility; decreased distortion and disadvantages are – need for special molten bath; process can be applied to limited number of steels.

Case Hardening

In case hardening, the surface of the steel is made hard and wear resistant, but the core remains soft and tough. Such a combination of properties is desired in applications such as gears.

Induction hardening

Here, an alternating current of high frequency passes through an induction coil enclosing the steel part to be heat treated. The induced *emf* heats the steel. The depth up to which the heat penetrates and raises the temperature above the elevated temperature is inversely proportional to the square root of the *ac* frequency. In induction hardening, the heating time is usually a few seconds. Immediately after heating, water jets are activated to quench the surface. Martensite is produced at the surface, making it hard and wear resistant. The microstructure of the core remains unaltered. Induction hardening is suitable for mass production of articles of uniform cross-section.

Flame hardening

For large work pieces and complicated cross-sections induction heating is not easy to apply. In such cases, flame hardening is done by means of an oxyacetylene torch. Heating should be done rapidly by the torch and the surface quenched, before appreciable heat transfer to the core occurs

Laser hardening

In this case, a laser beam can be used for surface hardening. As laser beams are of high intensity, a lens is used to reduce the intensity by producing a defocused spot of size ranging from 0.5 to 25 mm. Proper control of energy input is necessary to avoid melting. Laser hardening has the advantage of precise control over the area to be hardened, an ability to harden reentrant surfaces, very high speed of hardening and no separate quenching step. The disadvantage is that the hardening is shallower than in induction and flame hardening

Carburizing

Carburizing is the most widely used method of surface hardening. Here, the surface layers of low carbon steel are enriched with carbon up to 0.8-1.0%. The source of carbon may be a solid medium, a liquid or a gas. In all cases, the carbon enters the steel at the surface and diffuses into the steel as a function of time at an elevated temperature. Carburizing is done at 920-950^o C. This fully austenitic state is essential. If carburizing is done in the ferritic region, the carbon, with very limited solubility in ferrite, tends to form massive cementite particles near the surface, making the subsequent heat treatment difficult. For this reason, carburizing is always done in the austenitic state, even though longer times are required due to the diffusion rate of carbon in austenite being less than in ferrite at such temperatures.

Cyaniding

Cyaniding is done in a liquid bath of NaCN, with the concentration varying between 30 and 97%. The temperature used for cyaniding is lower than that for carburizing and is in the range of 800-870^o C. The time of cyaniding is 1-3 hr to produce a case depth of 0.25 mm or less.

Nitriding

Nitriding is carried out in the ferritic region. No phase change occurs after nitriding. The part to be nitrified should possess the required core properties prior to nitriding. During nitriding, pure ammonia decomposes to yield nitrogen which enters the steel. The solubility

of nitrogen in ferrite is small. Most of the nitrogen, that enters the steel, forms hard nitrides (e.g., Fe_3N). The temperature of nitriding is $500\text{-}590^\circ\text{C}$. The time for a case depth of 0.02 mm is about 2 hr . In addition to providing outstanding wear resistance, the nitride layer increases the resistance of carbon steel to corrosion in moist atmospheres.

Module 4

Optical properties of Materials

Optical property of a material is related to the interaction of it with electromagnetic radiation. This radiation may have characteristics that fall in the visible light spectrum, or may be even out of it. Electromagnetic spectrum of radiation spans the wide range from γ -rays with wavelength as 10^{-12} m, through x-rays, ultraviolet, visible, infrared, and finally radio waves with wavelengths as long as 10^5 m. Visible light is one form of electromagnetic radiation with wavelengths ranging from 0.39 to 0.77 μm . It contains color bands from violet through red, as shown in the *figure*. White light is simply a mixture of all colors. The ultraviolet region covers the range from about 0.01 to about 0.40 μm , and the infrared region extends from about 0.75 to 1000 μm .

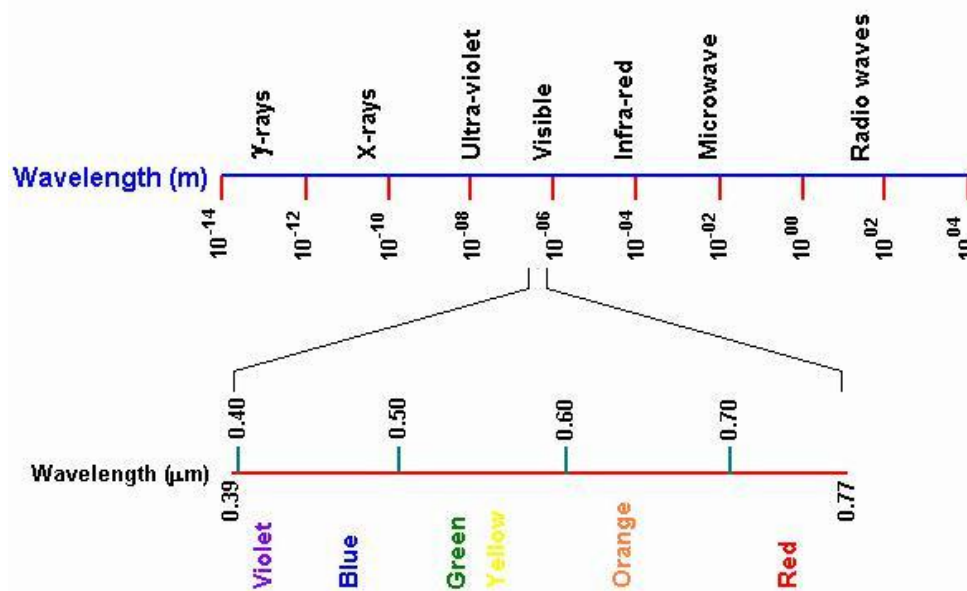

Figure- Wave length spectrum of electro-magnetic waves

The true nature of the light will probably never be known. However, light can be considered as having waves and consisting of particles called photons. The important characteristics of the photons are related by the following equation. This equation allows us to consider the photon as a particle of energy, or as a wave with a characteristic wavelength and frequency.

$$E = h\nu = \frac{hc_0}{\lambda}$$

where E – energy, h – Planck's constant (6.62×10^{-34} J.sec), ν – frequency, c_0 – speed of light in vacuum (3×10^8 m/sec), and λ – wavelength.

All materials interact in some way with light. Interaction of photons with the electronic or crystal structure of a material leads to a number of phenomena. The photons may give their energy to the material (absorption); photons give their energy, but photons of identical energy are immediately emitted by the material (reflection); photons may not interact with the material structure (transmission); *or* during transmission photons are changes in velocity (refraction).

At any instance of light interaction with a material, the total intensity of the incident light striking a surface is equal to sum of the absorbed, reflected, and transmitted intensities.

$$I_0 = I_A + I_R + I_T$$

The intensity is defined as the number of photons impinging on a surface per unit area per unit time. Materials that are capable of transmitting light with relatively little absorption and reflection are called *transparent materials* i.e. we can see through them. *Translucent materials* are those through which light is transmitted diffusely i.e. objects are not clearly distinguishable when viewed through. Those materials that are impervious to the transmission of visible light are termed as *opaque materials*.

Optical properties of metals and alloys

Typical characteristic of metals with respect to crystal structure is that they possess a high-energy band that is only partially filled with electrons. When visible light is directed on a metal surface, the energy is used to excite electrons into unoccupied energy states above the Fermi level, thus making metals behave as opaque materials i.e. light is absorbed. Except of thin sections, metals strongly reflect and/or absorb incident radiation for long wavelengths to the middle of the ultraviolet range i.e. metals are opaque to all electromagnetic radiation on the low end of the frequency spectrum, from radio waves,

through infrared, visible, into middle of the ultraviolet radiation. However, metals are transparent to high end frequencies, ex. x-ray and γ -ray radiation. Total absorption by metals is within a very thin outer layer, usually less than 0.1 μm ; thus only metallic films thinner than 0.1 μm are capable of transmitting visible light.

Most of the absorbed radiation is emitted from the metallic surface in the form of visible light of the same wavelength as reflected light. The reflectivity of metals is about 0.95, while the rest of impinged energy is dissipated as heat. The amount of energy absorbed by metals depends on the electronic structure of each particular metal. For example: with copper and gold there is greater absorption of the short wavelength colors such as green and blue and a greater reflection of yellow, orange and red wavelengths. Other metals such as silver and aluminium strongly reflect all parts of the visible spectrum and show a white silvery color.

Optical properties of non-metallic materials

By virtue of their electron structure with characteristic energy band structures, non-metallic materials may be transparent to visible lights. Thus, all four optical phenomena such as absorption, reflection, transmission and refraction are important for these materials.

Refraction:

When light photons are transmitted through a material, they causes polarization of the electrons in the material and by interacting with the polarized materials, photons lose some of their energy. As a result of this, the speed of light is reduced and the beam of light changes direction.

The relative velocity of light passing through a medium is expressed by the optical property called the index of refraction (n), and is defined as:

$$n = \frac{c_0}{c}$$

where c_0 – speed of light in vacuum, c – speed of light in the concerned material.

If the angle of incidence from a normal to the surface is θ_i , and the angle of refraction is θ_r , the refractive index of the medium, n , is given by

$$n = \frac{\sin \theta_i}{\sin \theta_r}$$

Reflection and refraction of light is shown in *figure*

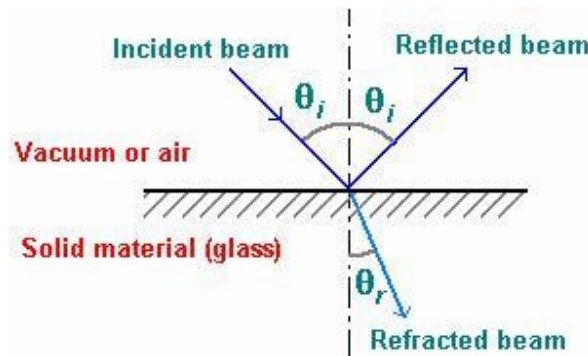

Figure- Reflection and refraction of light.

Optical phenomena

As mentioned in earlier sections, light interacts with a material in many ways. Depending on the material, its crystal-/micro-structure, and also on the characteristics of incident light, there are many peculiar phenomena occurs, which are known as optical phenomena. These include: luminescence, lasers, thermal emission, photo-conductivity, and optical fibers. All these find quite many applications in technology for every day life.

Luminescence: Luminescence is defined as the process in which a material absorbs energy and then immediately emits visible or near-visible radiation. This occurs as a result of excitation of electrons of a material from the valence band into the conduction band. The source of input energy may be high energy electrons *or* light photons. During luminescence, the excited electrons drop back to lower energy levels. If the emission takes place within 10^{-8} sec.s after excitation, the luminescence is called *fluorescence*, and if it takes longer than 10^{-8} sec.s, it is known as *phosphorescence*.

Luminescence takes place in outer valence- and conduction- bands, while x-rays are produced during electron transitions in the inner-energy levels of an atom. Luminescence does not occur in metals. In certain ceramics and semi-conductors, however, the energy gap between the valence and conduction bands is such that an electron dropping through this gap produces a photon in the visible range.

Lasers:

Laser is an acronym for *light amplification by stimulated emission of radiation*. It is in fact special application of luminescence. Unlike most radiation processes, such as luminescence, which produce incoherent light, the light produced by laser emission is coherent i.e. light waves are all in phase with each other. Consequently, laser light waves are does not spread out i.e. parallel, directional, and monochromatic i.e. entirely of one wavelength.

In certain materials, electrons excited by a stimulus produce photons which in turn excite additional photons of identical wavelength. Thus a large amplification of the photons emitted in the material occurs. By selecting stimulant and material properly, laser beam can be in the visible range. Lasers are useful in many applications such as welding, metal cutting, heat treatment, surgery, mapping, reading compact disks, etc. A variety of materials are used to produce lasers. Ex.: Ruby, single crystal of Al_2O_3 doped with little amount of Cr_2O_3 ; yttrium aluminium garnet ($\text{Y}_3\text{Al}_5\text{O}_{12}$ – YAG) doped with neodymium, Nd; CO_2 gas; He-Ne gas; some semi-conductors like GaAs and InGaAsP. Gas lasers generally produce lower intensities and powers, but are more suitable for continuous operation since solid-state lasers generate appreciable amounts of heat.

Laser operation: when the laser material is exposed to stimulant, for example flash lamp, electrons that initially fills the lowest-energy levels gets excited into higher energy-levels. These electrons can decay back by two paths: one in which they fall directly back associated photon emissions are not part of the laser beam; others decay into a intermediate meta-stable state where they reside for about 3 ms before spontaneous emission. This initial

spontaneous emission acts as stimulus and triggers an avalanche of emissions from remaining electrons in the meta-stable state. The photons are of the same energy and are in phase. The beam is collimated through the use of a tube with silvered mirrors at each end. As stimulated emission occurs, only those photons traveling nearly parallel to the long axis of the material are reflected. These reflected photons stimulate the emission of more photons. Reflected photons traveling up and down the length of the crystal produce ever-increasing number of stimulated photons. Finally, high-energy, highly-collimated, monochromatic beam of coherent light is emitted from the laser device.

Thermal emission:

When a material is heated, electrons are excited to higher energy levels, particularly in the outer energy levels where the electrons are less strongly bound to the nucleus. These excited electrons, upon dropping back to the ground state, release photons in process what is called *thermal emission*.

During thermal emission a continuous spectrum of radiation is emitted with a minimum wavelength and the intensity distribution is dependent on the temperature. Higher the temperature, wider will be the range of wavelengths emitted. By measuring the intensity of a narrow band of the emitted wavelengths with a pyrometer, material's temperature can be estimated.

Photo-conductivity:

As mentioned in earlier section upon absorption of photons at surface, electron may be released from its atom nucleus. Thus electricity can be generated from the surface of a metal when it is bombarded with photons. Similarly, bombardment of semiconductors by photons, with energy equal to greater than the band gap, may result in creation of electron-hole pairs that can be used to generate current. This process is called photo-conductivity, and is different from photo-electric effect in the sense that an electron-hole pair is generated whose energy is related to the band gap energy instead of free electron alone whose energy is related to the Fermi level. The current produced in photo-conductivity is directly related to the incident light intensity.

This phenomenon is utilized in photographic light meters. Cadmium sulfide (CdS) is commonly used for the detection of visible light, as in light meters. Photo-conductivity is also the underlying principle of the photo-voltaic cell, known to common man as solar cell, used for conversion of solar energy into electricity.

Optical fibers:

Recently the buzz word in the communications sector is the optical fiber, using in place of metallic copper wires. Signal transmission through a metallic wire conductor is electronic, whereas in fibers it is photonic i.e. by photons. This enables faster transmission at higher densities to longer distances with reduction in error rate. These systems consists of transmitter (a semiconductor laser) to convert electrical signals to light signals, optical fiber to transmit the light signals, and a photodiode to convert light signals back to electrical signals.

Optical fiber is the heart of the communication system. It must have extremely low loss of light, must be able to guide the light pulses over long distances without significant loss and/or distortion. It primarily consists of core, cladding and coating. The core transmits the signals, while the cladding constrains the light beam to the core; outer coating protects the core and cladding from the external environment. Optical fiber operates on the principle of total internal reflectance. Typically both the core and cladding are made of special types of glass with carefully controlled indices of refraction. The indices of refraction are selected such that

$$n_{cladding} < n_{core}$$

Once the light enters the core from the source, it is reflected internally and propagates along the length of the fiber. Internal reflection is accomplished by varying the index of refraction of the core and cladding glass materials. Usually two designs are employed in this regard. In step-index optical fiber, there is a sharp change in refractive index between the core and cladding. In this design output pulse will be broader than the input one. It is because light rays traveling in different trajectories have a variety of path lengths. It is possible to avoid pulse broadening by using graded-index fiber. This results in a helical path for the light

rays, as opposed to zig-zag path in a step-index fiber. Here impurities such as boron oxide (B_2O_3) or germanium dioxide (GeO_2) are added to the silica glass such that the index of refraction varied gradually in parabolic manner across the cross section. This enables light to travel faster while close to the periphery than at the center. This avoids pulse broadening i.e. light rays arrive at output at approximately same time. Both step- and graded- index fibers are termed as multi-mode fibers. Third type optical fiber is called single-mode fiber in which light travels largely parallel to the fiber axis with little distortion of the digital light pulse. These are used for long transmission lines.

Applications and Processing of Ceramics

Ceramics form an important part of materials group. Ceramics are compounds between metallic and nonmetallic elements for which the inter-atomic bonds are either ionic or predominantly ionic. The term ceramics comes from the Greek word *keramikos* which means 'burnt stuff'. Characteristic properties of ceramics are, in fact, optimized through thermal treatments. They exhibit physical properties those are different from that of metallic materials. Thus metallic materials, ceramics, and even polymers tend to complement each other in service.

Types and applications of ceramics

Ceramics greatly differ in their basic composition. The properties of ceramic materials also vary greatly due to differences in bonding, and thus found a wide range of engineering applications. Classification of ceramics based on their specific applications and composition are two most important ways among many. Based on their composition, ceramics are classified as:

- Oxides,
- Carbides,
- Nitrides,
- Sulfides,
- Fluorides, etc.

The other important classification of ceramics is based on their application, such as:

- Glasses,
- Clay products,
- Refractories,
- Abrasives,
- Cements, etc.

In general, ceramic materials used for engineering applications can be divided into two groups: traditional ceramics, and the engineering ceramics. Typically, traditional ceramics are made from three basic components: clay, silica (flint) and feldspar. For example bricks, tiles and porcelain articles. However, engineering ceramics consist of highly pure compounds of aluminium oxide (Al_2O_3), silicon carbide (SiC) and silicon nitride (Si_3N_4).

Glasses:

Glasses are a familiar group of ceramics – containers, windows, mirrors, lenses, etc. They are non-crystalline silicates containing other oxides, usually CaO, Na₂O, K₂O and Al₂O₃ which influence the glass properties and its color. Typical property of glasses that is important in engineering applications is its response to heating. There is no definite temperature at which the liquid transforms to a solid as with crystalline materials. A specific temperature, known as glass transition temperature or fictive temperature is defined based on viscosity above which material is named as super cooled liquid or liquid, and below it is termed as glass.

Clay products:

Clay is the one of most widely used ceramic raw material. It is found in great abundance and popular because of ease with which products are made. Clay products are mainly two kinds – structural products (bricks, tiles, sewer pipes) and white- wares (porcelain, chinaware, pottery, etc.).

Refractories:

These are described by their capacity to withstand high temperatures without melting or decomposing; and their inertness in severe environments. Thermal insulation is also an important functionality of refractories.

Abrasive ceramics:

These are used to grind, wear, or cut away other material. Thus the prime requisite for this group of materials is hardness or wear resistance in addition to high toughness. As they may also exposed to high temperatures, they need to exhibit some refractoriness. Diamond, silicon carbide, tungsten carbide, silica sand, aluminium oxide / corundum are some typical examples of abrasive ceramic materials.

Cements:

Cement, plaster of paris and lime come under this group of ceramics. The characteristic property of these materials is that when they are mixed with water, they form slurry which sets subsequently and hardens finally. Thus it is possible to form virtually any shape.

They are also used as bonding phase, for example between construction bricks.

Advanced ceramics:

These are newly developed and manufactured in limited range for specific applications. Usually their electrical, magnetic and optical properties and combination of properties are exploited. Typical applications: heat engines, ceramic armors, electronic packaging, etc.

Some typical ceramics and respective applications are as follows:

Aluminium oxide / Alumina (Al₂O₃):

It is one of most commonly used ceramic material. It is used in many applications such as to contain molten metal, where material is operated at very high temperatures under heavy loads, as insulators in spark plugs, and in some unique applications such as dental and medical use. Chromium doped alumina is used for making lasers.

Aluminium nitride (AlN):

Because of its typical properties such as good electrical insulation but high thermal conductivity, it is used in many electronic applications such as in electrical circuits operating at a high frequency. It is also suitable for integrated circuits. Other electronic ceramics include – barium titanate (BaTiO₃) and Cordierite (2MgO-2Al₂O₃-5SiO₂).

Diamond (C):

It is the hardest material known to available in nature. It has many applications such as industrial abrasives, cutting tools, abrasion resistant coatings, etc. it is, of course, also used in jewelry.

Lead zirconium titanate (PZT):

It is the most widely used piezoelectric material, and is used as gas igniters, ultrasound imaging, in underwater detectors.

Silica (SiO₂):

Silica is an essential ingredient in many engineering ceramics, thus is the most widely used

ceramic material. Silica-based materials are used in thermal insulation, abrasives, laboratory glassware, etc. it also found application in communications media as integral part of optical fibers. Fine particles of silica are used in tires, paints, etc.

Silicon carbide (SiC):

It is known as one of best ceramic material for very high temperature applications. It is used as coatings on other material for protection from extreme temperatures. It is also used as abrasive material. It is used as reinforcement in many metallic and ceramic based composites. It is a semiconductor and often used in high temperature electronics. Silicon nitride (Si_3N_4) has properties similar to those of SiC but is somewhat lower, and found applications in such as automotive and gas turbine engines.

Titanium oxide (TiO₂):

It is mostly found as pigment in paints. It also forms part of certain glass ceramics. It is used to making other ceramics like BaTiO_3 .

Titanium boride (TiB₂):

It exhibits great toughness properties and hence found applications in armor production. It is also a good conductor of both electricity and heat.

Uranium oxide (UO₂):

It is mainly used as nuclear reactor fuel. It has exceptional dimensional stability because its crystal structure can accommodate the products of fission process.

Yttrium aluminium garnet (YAG, Y₃Al₅O₁₂):

It has main application in lasers (Nd-YAG lasers).

Zirconia (ZrO₂):

It is also used in producing many other ceramic materials. It is also used in making oxygen gas sensors, as additive in many electronic ceramics. Its single crystals are part of jewelry.

Composites

There is a great need for materials with special properties with emergence of new technologies. However, conventional engineering materials are unable to meet this requirement of special properties like high strength and low density materials for aircraft applications. Thus, emerged new class of engineering materials – *composites*. Unfortunately, there is no widely accepted definition for a composite material. For the purpose of this module, the following definition is adopted: any multiphase material that is artificially made and exhibits a significant proportion of the properties of the constituent phases. The constituent phases of a composite are usually of macro sized portions, differ in form and chemical composition and essentially insoluble in each other.

Composites are, thus, made by combining two distinct engineering materials in most cases; one is called *matrix* that is continuous and surrounds the other phase – *dispersed phase*. The properties of composites are a function of the properties of the constituent phases, their relative amounts, and size-and-shape of dispersed phase.

Millions of combinations of materials are possible and thus so number of composite materials. For ease of recognition, composite materials are classified based on different criteria like: (1) type of matrix material – metal matrix composites, polymer matrix composites and ceramic matrix composites (2) size-and-shape of dispersed phase – particle-reinforced composites, fiber-reinforced composites and structural composites. It is understandable that properties of composite materials are nothing but improved version of properties of matrix materials due to presence of dispersed phase. However, engineers need to understand the mechanics involved in achieving the better properties. Hence the following sections highlight the mechanics of composites, which depend on size-and-shape of dispersed phase.

Particle-reinforced composites

This class of composites is most widely used composites mainly because they are widely available and cheap. They are again two kinds: dispersion-strengthened and particulate-

reinforced composites. These two classes are distinguishable based upon strengthening mechanism – dispersion-strengthened composites and particulate composites.

In *dispersion-strengthened composites*, particles are comparatively smaller, and are of 0.01-0.1 μm in size. Here the strengthening occurs at atomic/molecular level i.e. mechanism of strengthening is similar to that for precipitation hardening in metals where matrix bears the major portion of an applied load, while *dispersoids* hinder/impede the motion of dislocations. Examples: thoria (ThO_2) dispersed Ni-alloys (TD Ni-alloys) with high-temperature strength; SAP (sintered aluminium powder) – where aluminium matrix is dispersed with extremely small flakes of alumina (Al_2O_3).

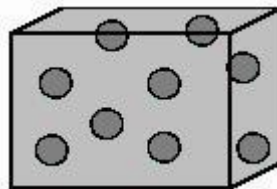

Figure- Particulate reinforced composite

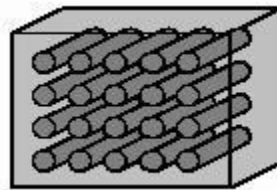

Figure- Particulate reinforced composite

Particulate composites are other class of particle-reinforced composites. These contain large amounts of comparatively coarse particles. These composites are designed to produce unusual combinations of properties rather than to improve the strength. Mechanical properties, such as elastic modulus, of particulate composites achievable are in the range defined by *rule of mixtures* as follows:

Upper bound is represented by:

$$E_c(u) = E_m V_m + E_p V_p$$

And lower bound is represented by

$$E_c(l) = \frac{E_m E_p}{E_p V_m + E_m V_p}$$

where E and V denote elastic modulus and volume fractions respectively while c , m , and p represent composite, matrix and particulate phases. A schematic diagram of these bounds is shown in the *figure*

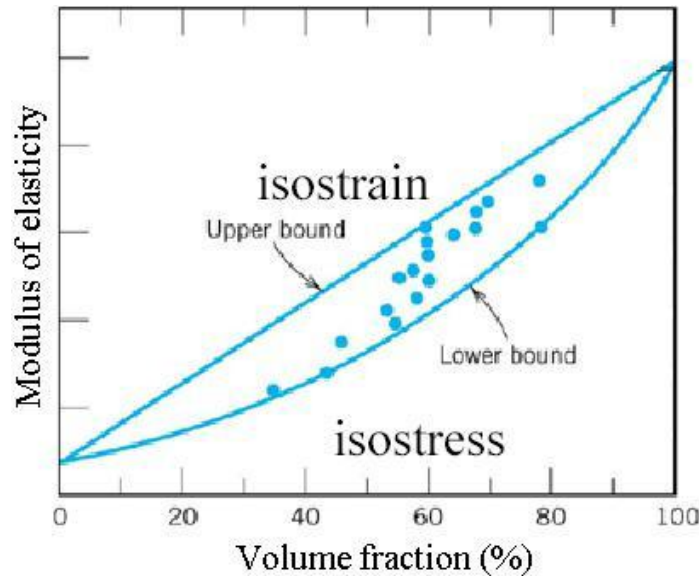

Figure- Schematic presentation of rule-of-mixture bounds.

Particulate composites are used with all three material types – metals, polymers and ceramics. Cermets contain hard ceramic particles dispersed in a metallic matrix. Eg.: tungsten carbide (WC) or titanium carbide (TiC) embedded cobalt or nickel used to make cutting tools. Polymers are frequently reinforced with various particulate materials such as carbon black. When added to vulcanized rubber, carbon black enhances toughness and abrasion resistance of the rubber. Aluminium alloy castings containing dispersed SiC particles are widely used for automotive applications including pistons and brake applications.

Concrete is most commonly used particulate composite. It consists of cement as binding medium and finely dispersed particulates of gravel in addition to fine aggregate (sand) and water. It is also known as Portland cement concrete. Its strength can be increased by additional reinforcement such as steel rods/mesh.

Fiber-reinforced composites

Most fiber-reinforced composites provide improved strength and other mechanical properties and strength-to-weight ratio by incorporating strong, stiff but brittle fibers into a softer, more ductile matrix. The matrix material acts as a medium to transfer the load to the fibers, which carry most off the applied load. The matrix also provides protection to fibers from external loads and atmosphere.

These composites are classified as either continuous or discontinuous. Generally, the highest strength and stiffness are obtained with continuous reinforcement. Discontinuous fibers are used only when manufacturing economics dictate the use of a process where the fibers must be in this form.

The mechanical properties of fiber-reinforced composites depend not only on the properties of the fiber but also on the degree of which an applied load is transmitted to the fibers by the matrix phase. Length of fibers, their orientation and volume fraction in addition to direction of external load application affects the mechanical properties of these composites.

Effect of fiber length: Some critical length (l_c) is necessary for effective strengthening and stiffening of the composite material, which is defined as:

$$l_c = \frac{\sigma_f^* d}{2\tau_c}$$

*
 σ_f^* – ultimate/tensile strength of the fiber, d – diameter of the fiber, τ_c – interface bond strength. Fibers for which $l \gg l_c$ (normally $l > 15 l_c$) are termed as continuous, discontinuous or short fibers on the other hand.

Structural composites

These are special class of composites, usually consists of both homogeneous and composite materials. Properties of these composites depend not only on the properties of the constituents but also on geometrical design of various structural elements. Two classes of these composites widely used are: laminar composites and sandwich structures.

Laminar composites:

There are composed of two-dimensional sheets/layers that have a preferred strength direction. These layers are stacked and cemented together according to the requirement. Materials used in their fabrication include: metal sheets, cotton, paper, woven glass fibers embedded in plastic matrix, etc. Examples: thin coatings, thicker protective coatings, claddings, bimetallics, laminates. Many laminar composites are designed to increase corrosion resistance while retaining low cost, high strength or light weight.

Sandwich structures:

These consist of thin layers of a facing material joined to a light weight filler material. Neither the filler material nor the facing material is strong or rigid, but the composite possesses both properties. Example: corrugated cardboard. The faces bear most of the in-plane loading and also any transverse bending stresses. Typical face materials include Al-alloys, fiber-reinforced plastics, titanium, steel and plywood. The core serves two functions – it separates the faces and resists deformations perpendicular to the face plane; provides a certain degree of shear rigidity along planes that are perpendicular to the faces. Typical materials for core are: foamed polymers, synthetic rubbers, inorganic cements, balsa wood. Sandwich structures are found in many applications like roofs, floors, walls of buildings, and in aircraft for wings, fuselage and tailplane skins.